



Official Results

3° TROFEO INTERNAZIONALE DI JUDO MONTEREALE VALCELLINA - 2018-03-18

U13 F -36 KG (Entries: 6)

| Cl. | Atleta | | Società | | P.ti |
|-----|------------------------|------------|---|----------|------|
| 1 | ALZETTA VANESSA | 2006-05-10 | POLISPORTIVA MONTEREALE SOCIETA DILETTANTISTICA | 06PN0523 | 10 |
| 2 | SALVADORI SARA | 2006-08-31 | POLISPORTIVA MONTEREALE SOCIETA DILETTANTISTICA | 06PN0523 | 6 |
| 3 | KHAZRI DUAA | 2006-11-14 | POL. AGOSTINO LANZI ASSOCIAZIONE SPORTIVA DILETTANTISTICA | 08PR1281 | 4 |
| 3 | AKEF SORAYA | 2006-10-17 | KYU SHIN DO KAI PARMA ASSOCIAZIONE SPORTIVA DILETTANTISTICA | 08PR1231 | 4 |
| 5 | BARTOLI VERONIKA | 2006-12-14 | A&R PALESTRE S.S.DILETTANTISTICA A R.L. | 06TS3610 | 0 |
| 5 | LOSARDO LIVIA_VITTORIA | 2006-07-17 | KYU SHIN DO KAI PARMA ASSOCIAZIONE SPORTIVA DILETTANTISTICA | 08PR1231 | 0 |

U13 F -40 KG (Entries: 2)

| Cl. | Atleta | | Società | | P.ti |
|-----|------------------|------------|---|----------|------|
| 1 | FEDRIGO ANGELIKA | 2006-03-19 | ASSOCIAZIONE SPORTIVA DILETTANTISTICA DOJO SACILE | 06PN1518 | 10 |
| 2 | QUARTUCCIO RITA | 2006-12-21 | A.S.DILETTANTISTICA SPORT TEAM JUDO UDINE | 06UD1674 | 6 |

U13 F -44 KG (Entries: 2)

| Cl. | Atleta | | Società | | P.ti |
|-----|--------------|------------|---|----------|------|
| 1 | SALERNO SARA | 2006-07-24 | A.S.DILETTANTISTICA SPORT TEAM JUDO UDINE | 06UD1674 | 10 |

U13 F -48 KG (Entries: 3)

| Cl. | Atleta | | Società | | P.ti |
|-----|--------------------|------------|---|----------|------|
| 1 | RUBERTI ROSSELLA | 2006-08-19 | A&R PALESTRE S.S.DILETTANTISTICA A R.L. | 06TS3610 | 10 |
| 2 | FERRARI VERONICA | 2006-01-14 | KYU SHIN DO KAI PARMA ASSOCIAZIONE SPORTIVA DILETTANTISTICA | 08PR1231 | 6 |
| 3 | TERENZANI GIOVANNA | 2006-02-13 | A.S.DILETTANTISTICA SPORT TEAM JUDO UDINE | 06UD1674 | 4 |

U13 F -57 KG (Entries: 3)

| Cl. | Atleta | | Società | | P.ti |
|-----|------------------|------------|---|----------|------|
| 1 | MITROVIC SARA | 2006-11-05 | ASSOCIAZIONE SPORTIVA DILETTANTISTICA JUDO CLUB KEN OTANI | 06TS0400 | 10 |
| 2 | FIorenza MELISSA | 2006-04-14 | A.S.DILETTANTISTICA SPORT TEAM JUDO UDINE | 06UD1674 | 6 |
| 3 | ARCARI ANGELICA | 2006-06-28 | POL. AGOSTINO LANZI ASSOCIAZIONE SPORTIVA DILETTANTISTICA | 08PR1281 | 4 |

| U13 M -36 KG (Entries: 12) | | | | |
|-----------------------------|-------------------|------------|--|-------------|
| Cl. | Atleta | | Società | P.ti |
| 1 | AZEEZ SHAHID | 2006-10-05 | POLISPORTIVA VILLANOVA ASSOCIAZIONE SPORTIVA DILETTANTISTICA JUDO LIB. | 06PN0690 10 |
| 2 | PITIS ANDREA | 2006-10-12 | ASSOCIAZIONE SPORTIVA DILETTANTISTICA JUDO KUROKI | 06UD0623 6 |
| 3 | GUARNIERI LORENZO | 2006-06-14 | ASSOCIAZIONE SPORTIVA DILETTANTISTICA POLISPORTIVA TAMAI SEZIONE JUDO LIBERTAS | 06PN1057 4 |
| 3 | LONGO LUCA | 2006-09-15 | A&R PALESTRE S.S.DILETTANTISTICA A R.L. | 06TS3610 4 |
| 5 | ZULIANI FRANCESCO | 2006-11-25 | ASSOCIAZIONE SPORTIVA DILETTANTISTICA JUDO CLUB GIANFRANCO FENATI | 06PN0103 0 |
| 5 | CUNEO DANIEL | 2006-05-31 | KYU SHIN DO KAI PARMA ASSOCIAZIONE SPORTIVA DILETTANTISTICA | 08PR1231 0 |
| 7 | GHIRARDI LUCA | 2006-05-21 | ASSOCIAZIONE SPORTIVA DILETTANTISTICA JUDO CLUB GIANFRANCO FENATI | 06PN0103 0 |
| 7 | DOBOSZ VITTORIO | 2006-07-29 | ASSOCIAZIONE SPORTIVA DILETTANTISTICA JUDO AZZANESE | 06PN0354 0 |
| 11 | MARAZZI VALENTINO | 2006-09-25 | KYU SHIN DO KAI PARMA ASSOCIAZIONE SPORTIVA DILETTANTISTICA | 08PR1231 0 |
| 11 | TREVISAN SAMUELE | 2006-10-13 | ASSOCIAZIONE SPORTIVA DILETTANTISTICA JUDO AZZANESE | 06PN0354 0 |
| 11 | ESPOSITO ALESSIO | 2006-09-29 | ASSOCIAZIONE SPORTIVA DILETTANTISTICA POLISPORTIVA DLF YAMA ARASHI JUDO UDINE | 06UD0736 0 |
| 11 | SPOCCI LORENZO | 2006-08-21 | KYU SHIN DO KAI PARMA ASSOCIAZIONE SPORTIVA DILETTANTISTICA | 08PR1231 0 |

| U13 M -40 KG (Entries: 9) | | | | |
|----------------------------|--------------------------|------------|---|-------------|
| Cl. | Atleta | | Società | P.ti |
| 1 | CORAZZA MATTEO | 2006-12-09 | ASSOCIAZIONE SPORTIVA DILETTANTISTICA DOJO SACILE | 06PN1518 10 |
| 2 | COLUSSO JACOPO | 2006-08-26 | ASSOCIAZIONE SPORTIVA DILETTANTISTICA POL.JUDO CLUB SHIMAI DOJO | 06UD1675 6 |
| 3 | MIANI EDOARDO | 2006-04-13 | A.S.DILETTANTISTICA SPORT TEAM JUDO UDINE | 06UD1674 4 |
| 3 | PERRONE MATTIA_MINH_TUAN | 2006-12-05 | A.S.DILETTANTISTICA TEAM JUDO TRIESTE | 06TS3219 4 |
| 5 | BORTOLIN FRANCESCO | 2006-09-03 | ASSOCIAZIONE SPORTIVA DILETTANTISTICA DOJO SACILE | 06PN1518 0 |
| 5 | LONGO FABIO | 2006-11-07 | ASSOCIAZIONE SPORTIVA DILETTANTISTICA POLISPORTIVA DLF YAMA ARASHI JUDO UDINE | 06UD0736 0 |
| 7 | MOLINARO MATTEO | 2006-03-30 | ASSOCIAZIONE SPORTIVA DILETTANTISTICA JUDO KUROKI | 06UD0623 0 |
| 7 | NIKULIN DMITRY | 2006-10-12 | ASSOCIAZIONE SPORTIVA DILETTANTISTICA POLISPORTIVA DLF YAMA ARASHI JUDO UDINE | 06UD0736 0 |
| 11 | MENDLER SIMONE | 2006-10-02 | A.S.DILETTANTISTICA SPORT TEAM JUDO UDINE | 06UD1674 0 |

| U13 M -45 KG (Entries: 10) | | | | |
|-----------------------------|-------------------|------------|---|-------------|
| Cl. | Atleta | | Società | P.ti |
| 1 | FINZI GABRIELE | 2006-04-20 | A.S.DILETTANTISTICA TEAM JUDO TRIESTE | 06TS3219 10 |
| 2 | CHIMENTO ANTONINO | 2006-08-07 | POLISPORTIVA MONTEREALE SOCIETA DILETTANTISTICA | 06PN0523 6 |
| 3 | VIDOTTI SIMONE | 2006-03-13 | ASSOCIAZIONE SPORTIVA DILETTANTISTICA POLISPORTIVA DLF YAMA ARASHI JUDO UDINE | 06UD0736 4 |
| 3 | PEZZETTA DENIS | 2006-08-29 | ASSOCIAZIONE SPORTIVA DILETTANTISTICA JUDO KUROKI | 06UD0623 4 |
| 5 | CONSIGLIO EDOARDO | 2006-12-30 | ASSOCIAZIONE SPORTIVA DILETTANTISTICA JUDO CLUB SAN VITO | 06PN0521 0 |
| 5 | VITI BATO | 2006-10-01 | A.S.DILETTANTISTICA TEAM JUDO TRIESTE | 06TS3219 0 |

Official Results / 3° TROFEO INTERNAZIONALE DI JUDO MONTEREALE VALCELLINA - 2018-03-18Italy

| | | | | | |
|----|---------------------|------------|---|----------|---|
| 7 | MACORINI LEONARDO | 2006-07-30 | SOCIETA GINNASTICA TRIESTINA ASSOCIAZIONE SPORTIVA DILETTANTISTICA | 06TS0002 | 0 |
| 7 | SIMEONI LIAM | 2006-12-09 | ASSOCIAZIONE SPORTIVA DILETTANTISTICA DOJO SACILE | 06PN1518 | 0 |
| 11 | CRAIGHERO FEDERICO | 2006-07-18 | ASSOCIAZIONE SPORTIVA DILETTANTISTICA JUDO KUROKI | 06UD0623 | 0 |
| 11 | COSTANTINI GABRIELE | 2006-03-23 | KYU SHIN DO KAI PARMA ASSOCIAZIONE SPORTIVA DILETTANTISTICA | 08PR1231 | 0 |

U13 M -50 KG (Entries: 5)

| Cl. | Atleta | | Società | | P.ti |
|-----|------------------|------------|---|----------|------|
| 1 | BENFATTO ELIA | 2006-07-31 | ASSOCIAZIONE SPORTIVA DILETTANTISTICA POL.JUDO CLUB SHIMAI DOJO | 06UD1675 | 10 |
| 2 | TAJARIOL DIEGO | 2006-09-22 | ASSOCIAZIONE SPORTIVA DILETTANTISTICA JUDO AZZANESE | 06PN0354 | 6 |
| 3 | LUCCHESI DAMIANO | 2006-10-23 | ASSOCIAZIONE SPORTIVA DILETTANTISTICA DOJO SACILE | 06PN1518 | 4 |
| 3 | DOMANCIC ENRICO | 2006-06-10 | ASSOCIAZIONE SPORTIVA DILETTANTISTICA POLISPORTIVA DLF YAMA ARASHI JUDO UDINE | 06UD0736 | 4 |
| 5 | GUENZA ABUSH | 2006-12-24 | KYU SHIN DO KAI PARMA ASSOCIAZIONE SPORTIVA DILETTANTISTICA | 08PR1231 | 0 |

U13 M -55 KG (Entries: 5)

| Cl. | Atleta | | Società | | P.ti |
|-----|-------------------------|------------|---|----------|------|
| 1 | RIZZI FILIPPO | 2006-04-02 | ASSOCIAZIONE SPORTIVA DILETTANTISTICA POL.JUDO CLUB SHIMAI DOJO | 06UD1675 | 10 |
| 2 | CIOFFI ENRICO | 2006-01-06 | POLISPORTIVA MONTEREALE SOCIETA DILETTANTISTICA | 06PN0523 | 6 |
| 3 | ZATTI ALESSANDRO_PIETRO | 2006-05-25 | ASSOCIAZIONE SPORTIVA DILETTANTISTICA POLISPORTIVA DLF YAMA ARASHI JUDO UDINE | 06UD0736 | 4 |
| 3 | PERESSINI MATHIA | 2006-09-05 | S.S.DILETTANTISTICA CORPO LIBERO srl | 06GO3590 | 4 |
| 5 | ZULIANI JACOPO | 2006-10-19 | ASSOCIAZIONE SPORTIVA DILETTANTISTICA POLISPORTIVA DLF YAMA ARASHI JUDO UDINE | 06UD0736 | 0 |

U13 M -60 KG (Entries: 2)

| Cl. | Atleta | | Società | | P.ti |
|-----|---------------|------------|---|----------|------|
| 1 | ZARA IVAN | 2006-09-22 | ASSOCIAZIONE SPORTIVA DILETTANTISTICA JUDO CLUB SAN VITO | 06PN0521 | 10 |
| 2 | ERRATH NICOLA | 2006-09-29 | ASSOCIAZIONE SPORTIVA DILETTANTISTICA POLISPORTIVA DLF YAMA ARASHI JUDO UDINE | 06UD0736 | 6 |

U13 M -66 KG (Entries: 3)

| Cl. | Atleta | | Società | | P.ti |
|-----|--------------------|------------|--|----------|------|
| 1 | DI_GENNARO MASSIMO | 2006-05-20 | SOCIETA GINNASTICA TRIESTINA ASSOCIAZIONE SPORTIVA DILETTANTISTICA | 06TS0002 | 10 |
| 2 | ROS CRTISTIAN | 2006-12-02 | ASSOCIAZIONE SPORTIVA DILETTANTISTICA POLISPORTIVA TAMAI SEZIONE JUDO LIBERTAS | 06PN1057 | 6 |
| 3 | HADENKO VITALII | 2006-04-22 | ASSOCIAZIONE SPORTIVA DILETTANTISTICA JUDO CLUB GIANFRANCO FENATI | 06PN0103 | 4 |

U15 F -44 KG (Entries: 3)

| Cl. | Atleta | | Società | | P.ti |
|-----|------------------|------------|---|----------|------|
| 1 | LO_GATTO FABIOLA | 2004-12-10 | A.S.DILETTANTISTICA SPORT TEAM JUDO UDINE | 06UD1674 | 10 |
| 2 | CIROI LISA | 2005-08-26 | ASSOCIAZIONE SPORTIVA DILETTANTISTICA POLISPORTIVA DLF YAMA ARASHI JUDO UDINE | 06UD0736 | 6 |

Official Results / 3° TROFEO INTERNAZIONALE DI JUDO MONTEREALE VALCELLINA - 2018-03-18Italy

| | | | | | |
|---|-----------------|------------|---|----------|---|
| 3 | FUMO ANNA_LUCIA | 2005-12-10 | A.S.DILETTANTISTICA SPORT TEAM JUDO UDINE | 06UD1674 | 4 |
|---|-----------------|------------|---|----------|---|

U15 F -48 KG (Entries: 7)

| Cl. | Atleta | | Società | | P.ti |
|-----|--------------------|------------|--|----------|------|
| 1 | STOPPARI EMMA | 2004-05-12 | SOCIETA GINNASTICA TRIESTINA ASSOCIAZIONE SPORTIVA DILETTANTISTICA | 06TS0002 | 10 |
| 2 | MORARU IRINA | 2005-10-03 | S.S.DILETTANTISTICA A R.L. UNINOMINALE D.L.F. TRIESTE | 06TS3542 | 6 |
| 3 | ROSSOLATO GIULIA | 2005-07-27 | POLISPORTIVA MONTEREALE SOCIETA DILETTANTISTICA | 06PN0523 | 4 |
| 3 | STOCCHI MARTINA | 2005-02-19 | KYU SHIN DO KAI PARMA ASSOCIAZIONE SPORTIVA DILETTANTISTICA | 08PR1231 | 4 |
| 5 | GENOVESE FRANCESCA | 2004-05-29 | POLISPORTIVA MONTEREALE SOCIETA DILETTANTISTICA | 06PN0523 | 0 |
| 5 | CONTE GLORIA | 2004-09-26 | KYU SHIN DO KAI PARMA ASSOCIAZIONE SPORTIVA DILETTANTISTICA | 08PR1231 | 0 |
| 7 | ZUZZI GRETA | 2005-06-29 | ASSOCIAZIONE SPORTIVA DILETTANTISTICA JUDO KUROKI | 06UD0623 | 0 |

U15 F -52 KG (Entries: 5)

| Cl. | Atleta | | Società | | P.ti |
|-----|------------------|------------|--|----------|------|
| 1 | MARI GAIA | 2004-01-08 | ASSOCIAZIONE SPORTIVA DILETTANTISTICA JUDO CLUB TOLMEZZO | 06UD0443 | 10 |
| 2 | CAMILOT CHIARA | 2004-08-03 | POLISPORTIVA VILLANOVA ASSOCIAZIONE SPORTIVA DILETTANTISTICA JUDO LIB. | 06PN0690 | 6 |
| 3 | BERTORA CAROLINA | 2004-04-08 | KYU SHIN DO KAI PARMA ASSOCIAZIONE SPORTIVA DILETTANTISTICA | 08PR1231 | 4 |
| 3 | CORTE TINA | 2004-10-28 | SOCIETA GINNASTICA TRIESTINA ASSOCIAZIONE SPORTIVA DILETTANTISTICA | 06TS0002 | 4 |
| 5 | CORADAZZI ANNA | 2005-09-21 | ASSOCIAZIONE SPORTIVA DILETTANTISTICA JUDO KUROKI | 06UD0623 | 0 |

U15 F -57 KG (Entries: 4)

| Cl. | Atleta | | Società | | P.ti |
|-----|-------------------|------------|--|----------|------|
| 1 | ROMANIN ARIANNA | 2004-03-20 | SOCIETA GINNASTICA TRIESTINA ASSOCIAZIONE SPORTIVA DILETTANTISTICA | 06TS0002 | 10 |
| 2 | GRECO GLORIA | 2004-05-01 | SOCIETA GINNASTICA TRIESTINA ASSOCIAZIONE SPORTIVA DILETTANTISTICA | 06TS0002 | 6 |
| 3 | GAMBETTA ANNALISA | 2005-02-12 | KYU SHIN DO KAI PARMA ASSOCIAZIONE SPORTIVA DILETTANTISTICA | 08PR1231 | 4 |
| 4 | COSENZA ILARIA | 2005-07-18 | ASSOCIAZIONE SPORTIVA DILETTANTISTICA JUDO KUROKI | 06UD0623 | 0 |

U15 F -63 KG (Entries: 4)

| Cl. | Atleta | | Società | | P.ti |
|-----|-----------------------|------------|--|----------|------|
| 1 | ALZETTA IOLE | 2005-04-29 | POLISPORTIVA MONTEREALE SOCIETA DILETTANTISTICA | 06PN0523 | 10 |
| 2 | CASTELLANI EVA | 2005-01-03 | ASSOCIAZIONE SPORTIVA DILETTANTISTICA POLISPORTIVA DLF YAMA ARASHI JUDO UDINE | 06UD0736 | 6 |
| 3 | PERISSINOTTO SILVIA | 2005-01-13 | A.S.DILETTANTISTICA SPORT TEAM JUDO UDINE | 06UD1674 | 4 |
| 4 | ZILIOI CAROLINA_ELISA | 2005-01-21 | ASSOCIAZIONE SPORTIVA DILETTANTISTICA POLISPORTIVA TAMAI SEZIONE JUDO LIBERTAS | 06PN1057 | 0 |

U15 F -70 KG (Entries: 3)

| Cl. | Atleta | | Società | | P.ti |
|-----|-------------------|------------|--|----------|------|
| 1 | PIANI SOFIA | 2004-10-20 | ISAO OKANO | | 10 |
| 2 | BORTOLIN MARIANNA | 2004-01-21 | POLISPORTIVA VILLANOVA ASSOCIAZIONE SPORTIVA DILETTANTISTICA JUDO LIB. | 06PN0690 | 6 |

Official Results / 3° TROFEO INTERNAZIONALE DI JUDO MONTEREALE VALCELLINA - 2018-03-18Italy

| | | | | | |
|---|-------------------|------------|--|----------|---|
| 3 | BATTISTELLA ZAIRA | 2005-10-29 | ASSOCIAZIONE SPORTIVA DILETTANTISTICA JUDO AZZANESE | 06PN0354 | 4 |
|---|-------------------|------------|--|----------|---|

U15 M +81 KG (Entries: 2)

| Cl. | Atleta | | Società | | P.ti |
|-----|-----------|------------|----------------------|--|------|
| 1 | PAPI EROS | 2004-08-07 | SEKAI BUDO PORDENONE | | 10 |
| 2 | mm nn | 2004-01-01 | sss | | 6 |

U15 M -42 KG (Entries: 12)

| Cl. | Atleta | | Società | | P.ti |
|-----|-----------------------------|------------|--|----------|------|
| 1 | DE_LUCA ALESSIO | 2004-08-14 | SOCIETA GINNASTICA TRIESTINA ASSOCIAZIONE SPORTIVA DILETTANTISTICA | 06TS0002 | 10 |
| 2 | DIONISIO FABIO | 2005-07-22 | ASSOCIAZIONE SPORTIVA DILETTANTISTICA JUDO CLUB TOLMEZZO | 06UD0443 | 6 |
| 3 | LARCHER IGNAZIO | 2004-09-15 | ASSOCIAZIONE SPORTIVA DILETTANTISTICA JUDO CLUB TOLMEZZO | 06UD0443 | 4 |
| 3 | BONDI ALESSIO | 2004-12-20 | POL. AGOSTINO LANZI ASSOCIAZIONE SPORTIVA DILETTANTISTICA | 08PR1281 | 4 |
| 5 | JULLIOT TIMOTEO_TOBIE_LOEIZ | 2005-03-05 | SOCIETA GINNASTICA TRIESTINA ASSOCIAZIONE SPORTIVA DILETTANTISTICA | 06TS0002 | 0 |
| 5 | MAZZEGA LODOVICO | 2005-12-31 | POLISPORTIVA MONTEREALE SOCIETA DILETTANTISTICA | 06PN0523 | 0 |
| 7 | ZANTEI SAMUELE | 2005-11-12 | KYU SHIN DO KAI PARMA ASSOCIAZIONE SPORTIVA DILETTANTISTICA | 08PR1231 | 0 |
| 7 | FAVETTA MARCO | 2005-05-25 | POLISPORTIVA MONTEREALE SOCIETA DILETTANTISTICA | 06PN0523 | 0 |
| 7 | FORABOSCO ANDREA | 2005-09-28 | ASSOCIAZIONE SPORTIVA DILETTANTISTICA JUDO KUROKI | 06UD0623 | 0 |
| 7 | MERLO MATTEO | 2004-12-10 | ASSOCIAZIONE SPORTIVA DILETTANTISTICA DOJO JUDO UDINE | 06UD1888 | 0 |
| 7 | BERGAMO TOMMASO | 2005-12-27 | ASSOCIAZIONE SPORTIVA DILETTANTISTICA POLISPORTIVA TAMAI SEZIONE JUDO LIBERTAS | 06PN1057 | 0 |
| 11 | PERESSINI RICCARDO | 2004-06-09 | ASSOCIAZIONE SPORTIVA DILETTANTISTICA JUDO CLUB GIANFRANCO FENATI | 06PN0103 | 0 |

U15 M -46 KG (Entries: 3)

| Cl. | Atleta | | Società | | P.ti |
|-----|---------------------|------------|---|----------|------|
| 1 | MEDAU LUCAS | 2005-08-07 | SOCIETA GINNASTICA TRIESTINA ASSOCIAZIONE SPORTIVA DILETTANTISTICA | 06TS0002 | 10 |
| 2 | MENNILLO ALESSANDRO | 2005-07-20 | KYU SHIN DO KAI PARMA ASSOCIAZIONE SPORTIVA DILETTANTISTICA | 08PR1231 | 6 |
| 3 | CASULA MATTEO | 2005-03-04 | ASSOCIAZIONE SPORTIVA DILETTANTISTICA POLISPORTIVA DLF YAMA ARASHI JUDO UDINE | 06UD0736 | 4 |

U15 M -50 KG (Entries: 6)

| Cl. | Atleta | | Società | | P.ti |
|-----|--------------------|------------|---|----------|------|
| 1 | SANTARSIERO SAMUEL | 2005-08-08 | SOCIETA GINNASTICA TRIESTINA ASSOCIAZIONE SPORTIVA DILETTANTISTICA | 06TS0002 | 10 |
| 2 | BORDIGNON DANIEL | 2005-05-11 | ASSOCIAZIONE SPORTIVA DILETTANTISTICA POLISPORTIVA DLF YAMA ARASHI JUDO UDINE | 06UD0736 | 6 |
| 3 | OTAY CHADY | 2004-06-14 | POL. AGOSTINO LANZI ASSOCIAZIONE SPORTIVA DILETTANTISTICA | 08PR1281 | 4 |
| 3 | TOMASI GIOVANNI | 2004-07-28 | SOCIETA GINNASTICA TRIESTINA ASSOCIAZIONE SPORTIVA DILETTANTISTICA | 06TS0002 | 4 |
| 5 | LATIANO MIRKO | 2005-03-01 | ASSOCIAZIONE SPORTIVA DILETTANTISTICA JUDO CLUB SAN VITO | 06PN0521 | 0 |
| 5 | CALZETTI LEONARDO | 2004-03-22 | KYU SHIN DO KAI PARMA ASSOCIAZIONE SPORTIVA DILETTANTISTICA | 08PR1231 | 0 |

| U15 M -55 KG (Entries: 15) | | | | | |
|-----------------------------|---------------------|------------|--|----------|------|
| Cl. | Atleta | | Società | | P.ti |
| 1 | CESCHIUTTI RICCARDO | 2004-11-26 | A.S.DILETTANTISTICA SPORT TEAM JUDO UDINE | 06UD1674 | 10 |
| 2 | BARDUS IACOPO | 2004-01-15 | ASSOCIAZIONE SPORTIVA DILETTANTISTICA JUDO KUROKI | 06UD0623 | 6 |
| 3 | SOFIA RICCARDO | 2004-12-09 | ASSOCIAZIONE SPORTIVA DILETTANTISTICA JUDO AZZANESE | 06PN0354 | 4 |
| 3 | MENEGATTI MATTIA | 2004-12-15 | POLISPORTIVA VILLANOVA ASSOCIAZIONE SPORTIVA DILETTANTISTICA JUDO LIB. | 06PN0690 | 4 |
| 5 | PASUT RICCARDO | 2004-03-20 | POLISPORTIVA VILLANOVA ASSOCIAZIONE SPORTIVA DILETTANTISTICA JUDO LIB. | 06PN0690 | 0 |
| 5 | RONCASTRI LORENZO | 2005-01-08 | ASSOCIAZIONE SPORTIVA DILETTANTISTICA POLISPORTIVA DLF YAMA ARASHI JUDO UDINE | 06UD0736 | 0 |
| 7 | CIGALOTTO ANDREA | 2004-11-01 | ASSOCIAZIONE SPORTIVA DILETTANTISTICA POLISPORTIVA TAMAI SEZIONE JUDO LIBERTAS | 06PN1057 | 0 |
| 7 | ROSSI ALEX | 2004-08-13 | ASSOCIAZIONE SPORTIVA DILETTANTISTICA JUDO CLUB GIANFRANCO FENATI | 06PN0103 | 0 |
| 7 | LANZI LUCA | 2004-04-05 | POL. AGOSTINO LANZI ASSOCIAZIONE SPORTIVA DILETTANTISTICA | 08PR1281 | 0 |
| 11 | BERTOLO MATTIA | 2005-07-02 | POLISPORTIVA MONTEREALE SOCIETA DILETTANTISTICA | 06PN0523 | 0 |
| 11 | BARATTINI GIANMARCO | 2005-03-19 | KYU SHIN DO KAI PARMA ASSOCIAZIONE SPORTIVA DILETTANTISTICA | 08PR1231 | 0 |
| 11 | PELLEGRINI STEFANO | 2005-10-31 | ASSOCIAZIONE SPORTIVA DILETTANTISTICA JUDO KUROKI | 06UD0623 | 0 |
| 11 | TURLONI MATTEO | 2004-06-22 | A.S.DILETTANTISTICA SPORT TEAM JUDO UDINE | 06UD1674 | 0 |
| 11 | ARSENI VITTORIO | 2005-08-17 | KYU SHIN DO KAI PARMA ASSOCIAZIONE SPORTIVA DILETTANTISTICA | 08PR1231 | 0 |
| 11 | DI_GREGORIO LUCA | 2005-01-13 | A.S.DILETTANTISTICA SPORT TEAM JUDO UDINE | 06UD1674 | 0 |

| U15 M -60 KG (Entries: 14) | | | | | |
|-----------------------------|--------------------------|------------|--|----------|------|
| Cl. | Atleta | | Società | | P.ti |
| 1 | CESCHIUTTI ALESSANDRO | 2004-11-26 | A.S.DILETTANTISTICA SPORT TEAM JUDO UDINE | 06UD1674 | 10 |
| 2 | RIGONI ALESSANDRO | 2004-03-23 | KYU SHIN DO KAI PARMA ASSOCIAZIONE SPORTIVA DILETTANTISTICA | 08PR1231 | 6 |
| 3 | CHIARI NICOLA | 2004-03-02 | A.S.DILETTANTISTICA GALAXY VOLLEY | 08PR3510 | 4 |
| 3 | POLO_GRAVA MANUEL | 2004-03-23 | ASSOCIAZIONE SPORTIVA DILETTANTISTICA POL.JUDO CLUB SHIMAI DOJO | 06UD1675 | 4 |
| 5 | TERENZANI PIETRO_ANTONIO | 2004-01-15 | A.S.DILETTANTISTICA SPORT TEAM JUDO UDINE | 06UD1674 | 0 |
| 5 | GABBI SAMUELE | 2004-09-21 | KYU SHIN DO KAI PARMA ASSOCIAZIONE SPORTIVA DILETTANTISTICA | 08PR1231 | 0 |
| 7 | SIBAU JACOPO | 2004-03-16 | ASSOCIAZIONE SPORTIVA DILETTANTISTICA DOJO JUDO UDINE | 06UD1888 | 0 |
| 7 | PASQUI FRANCESCO | 2005-04-24 | ASSOCIAZIONE SPORTIVA DILETTANTISTICA JUDO CLUB TOLMEZZO | 06UD0443 | 0 |
| 7 | MENIS DANIELE | 2005-02-09 | ASSOCIAZIONE SPORTIVA DILETTANTISTICA JUDO KUROKI | 06UD0623 | 0 |
| 11 | CLOCCHIATTI DANIEL | 2005-09-26 | ASSOCIAZIONE SPORTIVA DILETTANTISTICA JUDO KUROKI | 06UD0623 | 0 |
| 11 | RODARO GIOVANNI_GABRIEL | 2005-06-21 | ASSOCIAZIONE SPORTIVA DILETTANTISTICA POLISPORTIVA DLF YAMA ARASHI JUDO UDINE | 06UD0736 | 0 |
| 11 | PIVETTA FRANCESCO | 2005-10-22 | ASSOCIAZIONE SPORTIVA DILETTANTISTICA POLISPORTIVA TAMAI SEZIONE JUDO LIBERTAS | 06PN1057 | 0 |
| 11 | CORRADINI VALERIO | 2004-08-03 | S.S.DILETTANTISTICA CORPO LIBERO srl | 06GO3590 | 0 |
| 11 | MARTINUZZI GIANMARIA | 2004-05-12 | SEKAI BUDO PORDENONE | | 0 |

| U15 M -66 KG (Entries: 9) | | | | |
|----------------------------|---------------------|------------|---|----------------|
| Cl. | Atleta | | Società | P.ti |
| 1 | MEDAU MANUEL | 2004-03-28 | SOCIETA GINNASTICA TRIESTINA ASSOCIAZIONE SPORTIVA DILETTANTISTICA | 06TS0002 10 |
| 2 | BORTUZZO ALESSANDRO | 2004-04-03 | ASSOCIAZIONE SPORTIVA DILETTANTISTICA JUDO CLUB GIANFRANCO FENATI | 06PN0103 6 |
| 3 | PIRAS ALESSANDRO | 2004-06-04 | ASSOCIAZIONE SPORTIVA DILETTANTISTICA JUDO CLUB SAN VITO | 06PN0521 4 |
| 3 | PERESSINI MATTIA | 2004-03-09 | ASSOCIAZIONE SPORTIVA DILETTANTISTICA JUDO CLUB SAN VITO | 06PN0521 4 |
| 5 | DESIATO GAETANO | 2004-03-07 | ASSOCIAZIONE SPORTIVA DILETTANTISTICA JUDO CLUB SAN VITO | 06PN0521 0 |
| 5 | MARCON FRANCESCO | 2004-09-30 | ASSOCIAZIONE SPORTIVA DILETTANTISTICA JUDO CLUB SAN VITO | 06PN0521 0 |
| 7 | CUCH ALESSIO | 2005-01-12 | ASSOCIAZIONE SPORTIVA DILETTANTISTICA DOJO SACILE | 06PN1518 0 |
| 7 | PANIZZIERI EMANUELE | 2005-04-28 | KYU SHIN DO KAI PARMA ASSOCIAZIONE SPORTIVA DILETTANTISTICA | 08PR1231 0 |
| 7 | SANTAROSSA SIMONE | 2004-08-13 | ASSOCIAZIONE SPORTIVA DILETTANTISTICA JUDO AZZANESE | 06PN0354 0 |

| U15 M -73 KG (Entries: 6) | | | | |
|----------------------------|-------------------|------------|---|----------------|
| Cl. | Atleta | | Società | P.ti |
| 1 | OWUSU HENRY_ASARE | 2004-05-11 | KYU SHIN DO KAI PARMA ASSOCIAZIONE SPORTIVA DILETTANTISTICA | 08PR1231 10 |
| 2 | MENAZZI NICCOLO | 2004-11-04 | ASSOCIAZIONE SPORTIVA DILETTANTISTICA POLISPORTIVA DLF YAMA ARASHI JUDO UDINE | 06UD0736 6 |
| 3 | SERODINE SAMUEL | 2004-02-08 | POLISPORTIVA VILLANOVA ASSOCIAZIONE SPORTIVA DILETTANTISTICA JUDO LIB. | 06PN0690 4 |
| 3 | RUMELEA DAVID | 2005-05-07 | ASSOCIAZIONE SPORTIVA DILETTANTISTICA JUDO CLUB SAN VITO | 06PN0521 4 |
| 5 | CAMPION MATTIA | 2005-03-21 | ASSOCIAZIONE SPORTIVA DILETTANTISTICA JUDO CLUB GIANFRANCO FENATI | 06PN0103 0 |
| 5 | MUNARETTO LUCA | 2005-10-11 | ASSOCIAZIONE SPORTIVA DILETTANTISTICA JUDO AZZANESE | 06PN0354 0 |

| U15 M -81 KG (Entries: 2) | | | | |
|----------------------------|---------------|------------|--|---------------|
| Cl. | Atleta | | Società | P.ti |
| 1 | POLOTTO MARCO | 2004-02-08 | SEKAI BUDO PORDENONE | 10 |
| 2 | ZANIN ITAN | 2005-01-14 | ASSOCIAZIONE SPORTIVA DILETTANTISTICA POLISPORTIVA TAMAI SEZIONE JUDO LIBERTAS | 06PN1057 6 |

| U18 F -48 KG (Entries: 5) | | | | |
|----------------------------|-----------------------|------------|--|----------------|
| Cl. | Atleta | | Società | P.ti |
| 1 | MONTANI ALESSIA | 2003-02-03 | KYU SHIN DO KAI PARMA ASSOCIAZIONE SPORTIVA DILETTANTISTICA | 08PR1231 10 |
| 2 | TASSIANO SILVIA | 2003-04-15 | KYU SHIN DO KAI PARMA ASSOCIAZIONE SPORTIVA DILETTANTISTICA | 08PR1231 6 |
| 3 | AKEF RAISSA | 2003-05-07 | POL. AGOSTINO LANZI ASSOCIAZIONE SPORTIVA DILETTANTISTICA | 08PR1281 4 |
| 3 | BRETTI ANNA | 2001-07-01 | ASSOCIAZIONE SPORTIVA DILETTANTISTICA DOJO JUDO UDINE | 06UD1888 4 |
| 5 | ZANINI ANNA_MADDALENA | 2003-04-07 | A.S.DILETTANTISTICA SPORT TEAM JUDO UDINE | 06UD1674 0 |

| U18 F -57 KG (Entries: 5) | | | | |
|----------------------------|--------------------|------------|---|----------------|
| Cl. | Atleta | | Società | P.ti |
| 1 | IORDACHE ALEXANDRA | 2003-06-11 | POLISPORTIVA VILLANOVA ASSOCIAZIONE SPORTIVA DILETTANTISTICA JUDO LIB. | 06PN0690 10 |
| 2 | CASTELLAN GRETA | 2003-03-05 | A.S.DILETTANTISTICA SPORT TEAM JUDO UDINE | 06UD1674 6 |

Official Results / 3° TROFEO INTERNAZIONALE DI JUDO MONTEREALE VALCELLINA - 2018-03-18italy

| | | | | | |
|---|-----------------|------------|---|----------|---|
| 3 | SLAVICA ANDJELA | 2003-04-02 | SOCIETA GINNASTICA TRIESTINA ASSOCIAZIONE SPORTIVA DILETTANTISTICA | 06TS0002 | 4 |
| 3 | SINCOVICH SOFIA | 2003-11-11 | A.S.C.Dilettantistica BEAR BROTHERS CLUB | 06TS3975 | 4 |
| 5 | ANTONINI ASIA | 2001-04-10 | POLISPORTIVA MONTEREALE SOCIETA DILETTANTISTICA | 06PN0523 | 0 |

U18 F -63 KG (Entries: 5)

| Cl. | Atleta | | Società | | P.ti |
|-----|--------------------|------------|--|----------|------|
| 1 | LORENZON ASIA | 2001-10-17 | ASSOCIAZIONE SPORTIVA DILETTANTISTICA POLISPORTIVA TAMAI SEZIONE JUDO LIBERTAS | 06PN1057 | 10 |
| 2 | LONGO GIULIA | 2003-08-14 | A&R PALESTRE S.S.DILETTANTISTICA A R.L. | 06TS3610 | 6 |
| 3 | COMELLI EMMA | 2003-12-07 | KYU SHIN DO KAI PARMA ASSOCIAZIONE SPORTIVA DILETTANTISTICA | 08PR1231 | 4 |
| 3 | SIROTTI RACHELE | 2003-04-08 | A&R PALESTRE S.S.DILETTANTISTICA A R.L. | 06TS3610 | 4 |
| 5 | MENEGHEL FRANCESCA | 2003-08-31 | ASSOCIAZIONE SPORTIVA DILETTANTISTICA JUDO AZZANESE | 06PN0354 | 0 |

U18 M -50 KG (Entries: 2)

| Cl. | Atleta | | Società | | P.ti |
|-----|---------------------|------------|--|----------|------|
| 1 | MIROLO MATTEO | 2003-01-03 | ASSOCIAZIONE SPORTIVA DILETTANTISTICA JUDO CLUB GIANFRANCO FENATI | 06PN0103 | 10 |
| 2 | VALOOKARAN CRISTIAN | 2003-10-19 | A.S.DILETTANTISTICA SPORT TEAM JUDO UDINE | 06UD1674 | 6 |

U18 M -55 KG (Entries: 7)

| Cl. | Atleta | | Società | | P.ti |
|-----|-------------------|------------|---|----------|------|
| 1 | CORTE MARCO | 2002-10-08 | SOCIETA GINNASTICA TRIESTINA ASSOCIAZIONE SPORTIVA DILETTANTISTICA | 06TS0002 | 10 |
| 2 | ISPIRO SIMONE | 2003-06-07 | SOCIETA GINNASTICA TRIESTINA ASSOCIAZIONE SPORTIVA DILETTANTISTICA | 06TS0002 | 6 |
| 3 | DI GIULIO MICHELE | 2003-04-01 | A.S.DILETTANTISTICA TEAM JUDO TRIESTE | 06TS3219 | 4 |
| 3 | GROSSI CRISTIAN | 2001-05-18 | KYU SHIN DO KAI PARMA ASSOCIAZIONE SPORTIVA DILETTANTISTICA | 08PR1231 | 4 |
| 5 | GIORDANO GIACOMO | 2003-11-14 | UNIONE GINNASTICA GORIZIANA SOCIETA SPORTIVA DILETTANTISTICA | 06GO0004 | 0 |
| 5 | FERRARI FEDERICO | 2003-10-20 | KYU SHIN DO KAI PARMA ASSOCIAZIONE SPORTIVA DILETTANTISTICA | 08PR1231 | 0 |
| 7 | LUCIAC NICOLAS | 2003-12-09 | KYU SHIN DO KAI PARMA ASSOCIAZIONE SPORTIVA DILETTANTISTICA | 08PR1231 | 0 |

U18 M -60 KG (Entries: 7)

| Cl. | Atleta | | Società | | P.ti |
|-----|-----------------------|------------|---|----------|------|
| 1 | ROMANIN GIANLUCA | 2002-06-04 | SOCIETA GINNASTICA TRIESTINA ASSOCIAZIONE SPORTIVA DILETTANTISTICA | 06TS0002 | 10 |
| 2 | CORONGIU SIMONE | 2003-04-10 | SOCIETA GINNASTICA TRIESTINA ASSOCIAZIONE SPORTIVA DILETTANTISTICA | 06TS0002 | 6 |
| 3 | BIANCIFIORI FRANCESCO | 2001-09-25 | ASSOCIAZIONE SPORTIVA DILETTANTISTICA JUDO AZZANESE | 06PN0354 | 4 |
| 3 | BALDINI LUCA | 2003-02-03 | KYU SHIN DO KAI PARMA ASSOCIAZIONE SPORTIVA DILETTANTISTICA | 08PR1231 | 4 |
| 5 | BORGHESE PAOLO | 2003-05-24 | POLISPORTIVA MONTEREALE SOCIETA DILETTANTISTICA | 06PN0523 | 0 |
| 5 | VIVA ALESSANDRO | 2003-02-21 | POLISPORTIVA VILLANOVA ASSOCIAZIONE SPORTIVA DILETTANTISTICA JUDO LIB. | 06PN0690 | 0 |
| 7 | COSTIN VLAD | 2003-07-08 | A.S.DILETTANTISTICA GALAXY VOLLEY | 08PR3510 | 0 |

U18 M -66 KG (Entries: 10)

| Cl. | Atleta | | Società | | P.ti |
|-----|-----------------|------------|---|----------|------|
| 1 | MARTIN ANDREA | 2003-04-01 | POLISPORTIVA VILLANOVA ASSOCIAZIONE SPORTIVA DILETTANTISTICA JUDO LIB. | 06PN0690 | 10 |
| 2 | ZOMERO EMANUELE | 2002-11-02 | ASSOCIAZIONE SPORTIVA DILETTANTISTICA JUDO CLUB GIANFRANCO FENATI | 06PN0103 | 6 |

Official Results / 3° TROFEO INTERNAZIONALE DI JUDO MONTEREALE VALCELLINA - 2018-03-18Italy

| | | | | | |
|----|------------------------|------------|--|----------|---|
| 3 | FRANZIL FEDERICO | 2003-12-03 | A.S.DILETTANTISTICA SPORT TEAM JUDO UDINE | 06UD1674 | 4 |
| 3 | FABRIS ANDREA | 2003-05-20 | ASSOCIAZIONE SPORTIVA DILETTANTISTICA JUDO AZZANESE | 06PN0354 | 4 |
| 5 | LOSTUZZI TIZIANO | 2002-09-23 | A&R PALESTRE S.S.DILETTANTISTICA A R.L. | 06TS3610 | 0 |
| 5 | GARAU ALESSANDRO | 2001-08-26 | ASSOCIAZIONE SPORTIVA DILETTANTISTICA JUDO KUROKI | 06UD0623 | 0 |
| 7 | CONSIGLIO PIERFEDERICO | 2003-11-11 | ASSOCIAZIONE SPORTIVA DILETTANTISTICA JUDO CLUB SAN VITO | 06PN0521 | 0 |
| 7 | ROVEREDO ELIA | 2002-02-05 | POLISPORTIVA MONTEREALE SOCIETA DILETTANTISTICA | 06PN0523 | 0 |
| 7 | MOSESCU DAVID_NICHOLAS | 2003-02-20 | ASSOCIAZIONE SPORTIVA DILETTANTISTICA JUDO CLUB GIANFRANCO FENATI | 06PN0103 | 0 |
| 11 | CASTORO NICOLA | 2003-01-07 | POLISPORTIVA VILLANOVA ASSOCIAZIONE SPORTIVA DILETTANTISTICA JUDO LIB. | 06PN0690 | 0 |

U18 M -73 KG (Entries: 9)

| Cl. | Atleta | | Società | | P.ti |
|-----|-------------------------|------------|--|----------|------|
| 1 | MUSIZZA TOMMASO | 2002-03-19 | SOCIETA GINNASTICA TRIESTINA ASSOCIAZIONE SPORTIVA DILETTANTISTICA | 06TS0002 | 10 |
| 2 | BATTISTON DAVIDE | 2002-05-28 | ASSOCIAZIONE SPORTIVA DILETTANTISTICA JUDO AZZANESE | 06PN0354 | 6 |
| 3 | BISON TOMMASO | 2002-01-31 | ASSOCIAZIONE SPORTIVA DILETTANTISTICA POL.JUDO CLUB SHIMAI DOJO | 06UD1675 | 4 |
| 3 | SERA CARLO | 2002-11-24 | ASSOCIAZIONE SPORTIVA DILETTANTISTICA JUDO CLUB SAN VITO | 06PN0521 | 4 |
| 5 | PARIN FABIO | 2003-11-23 | ASSOCIAZIONE SPORTIVA DILETTANTISTICA POL.JUDO CLUB SHIMAI DOJO | 06UD1675 | 0 |
| 5 | DANGELO ALESSIO | 2001-03-23 | ASSOCIAZIONE SPORTIVA DILETTANTISTICA JUDO AZZANESE | 06PN0354 | 0 |
| 7 | TOTIS JACOPO | 2003-05-17 | ASSOCIAZIONE SPORTIVA DILETTANTISTICA POL.JUDO CLUB SHIMAI DOJO | 06UD1675 | 0 |
| 7 | CASTORO VINCENZO_DAVIDE | 2003-01-07 | POLISPORTIVA VILLANOVA ASSOCIAZIONE SPORTIVA DILETTANTISTICA JUDO LIB. | 06PN0690 | 0 |
| 7 | POCI RICCARDO | 2003-08-15 | ASSOCIAZIONE SPORTIVA DILETTANTISTICA JUDO CLUB GIANFRANCO FENATI | 06PN0103 | 0 |

U18 M -81 KG (Entries: 4)

| Cl. | Atleta | | Società | | P.ti |
|-----|-------------------|------------|--|----------|------|
| 1 | MOURLLOT LEONARDO | 2001-04-02 | ASSOCIAZIONE SPORTIVA DILETTANTISTICA JUDO AZZANESE | 06PN0354 | 10 |
| 2 | FULIGNI AMOS | 2003-05-31 | ASSOCIAZIONE SPORTIVA DILETTANTISTICA POL.JUDO CLUB SHIMAI DOJO | 06UD1675 | 6 |
| 3 | MARZARO GABRIELE | 2002-02-02 | ASSOCIAZIONE SPORTIVA DILETTANTISTICA JUDO KUROKI | 06UD0623 | 4 |
| 4 | DE_MARIN RICCARDO | 2003-12-06 | ASSOCIAZIONE SPORTIVA DILETTANTISTICA POLISPORTIVA TAMAI SEZIONE JUDO LIBERTAS | 06PN1057 | 0 |

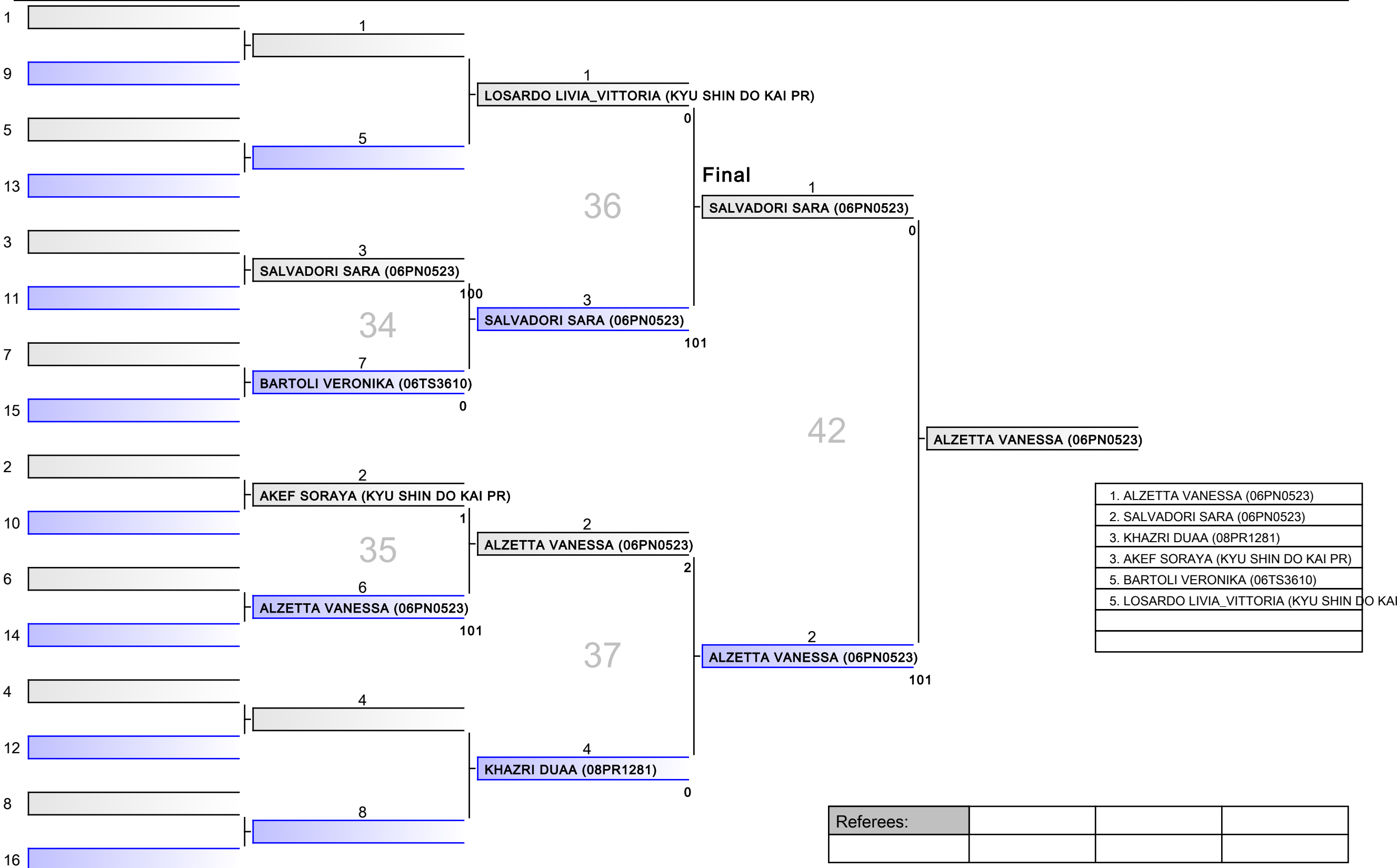

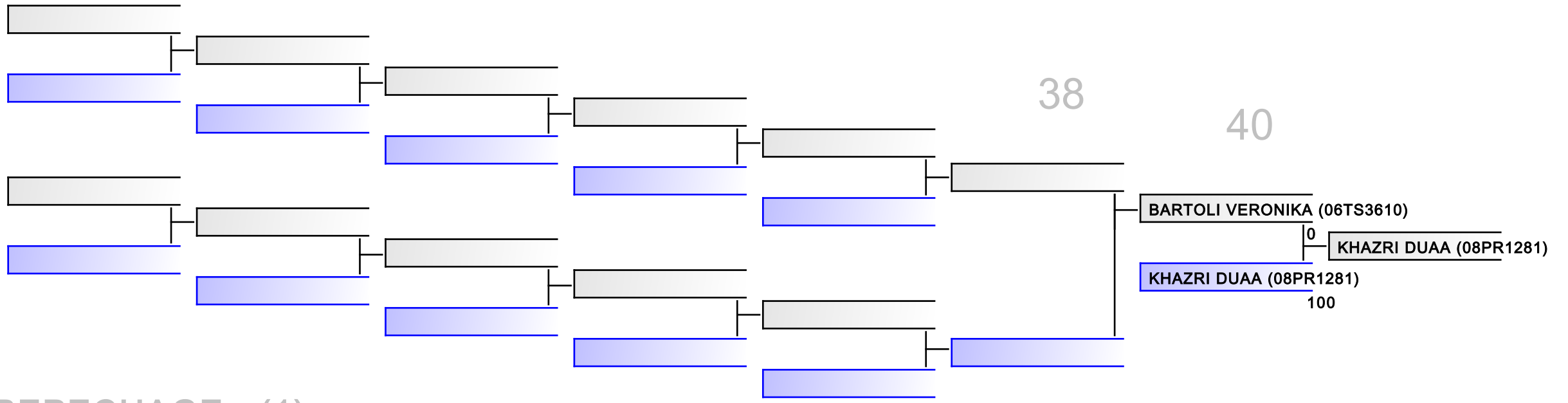

REPECHAGE: (1)

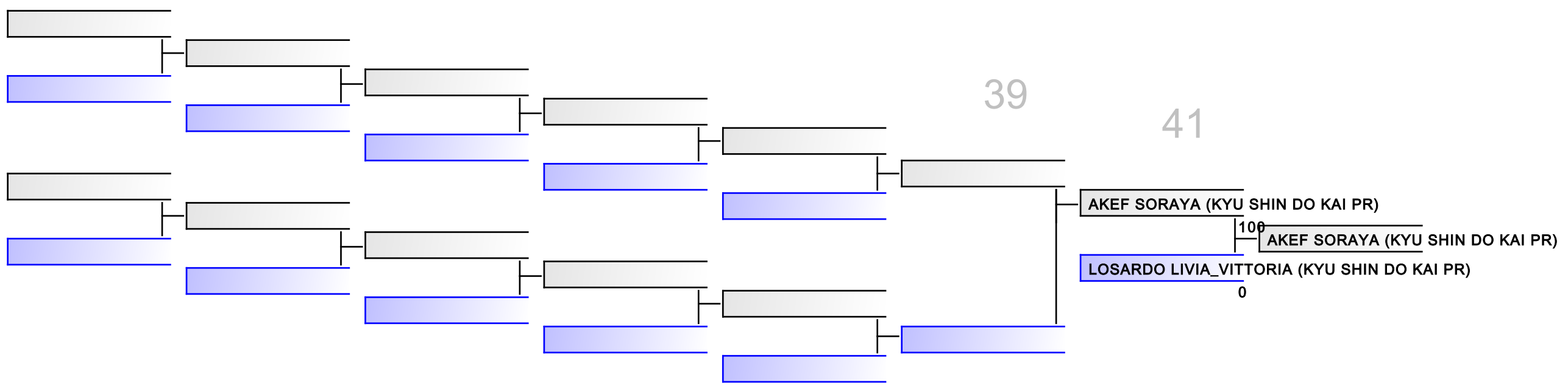

| | | | | | | | |
|-----------|--|--|--|--|--|--|--|
| Referees: | | | | | | | |
|-----------|--|--|--|--|--|--|--|

U13 F -40 KG

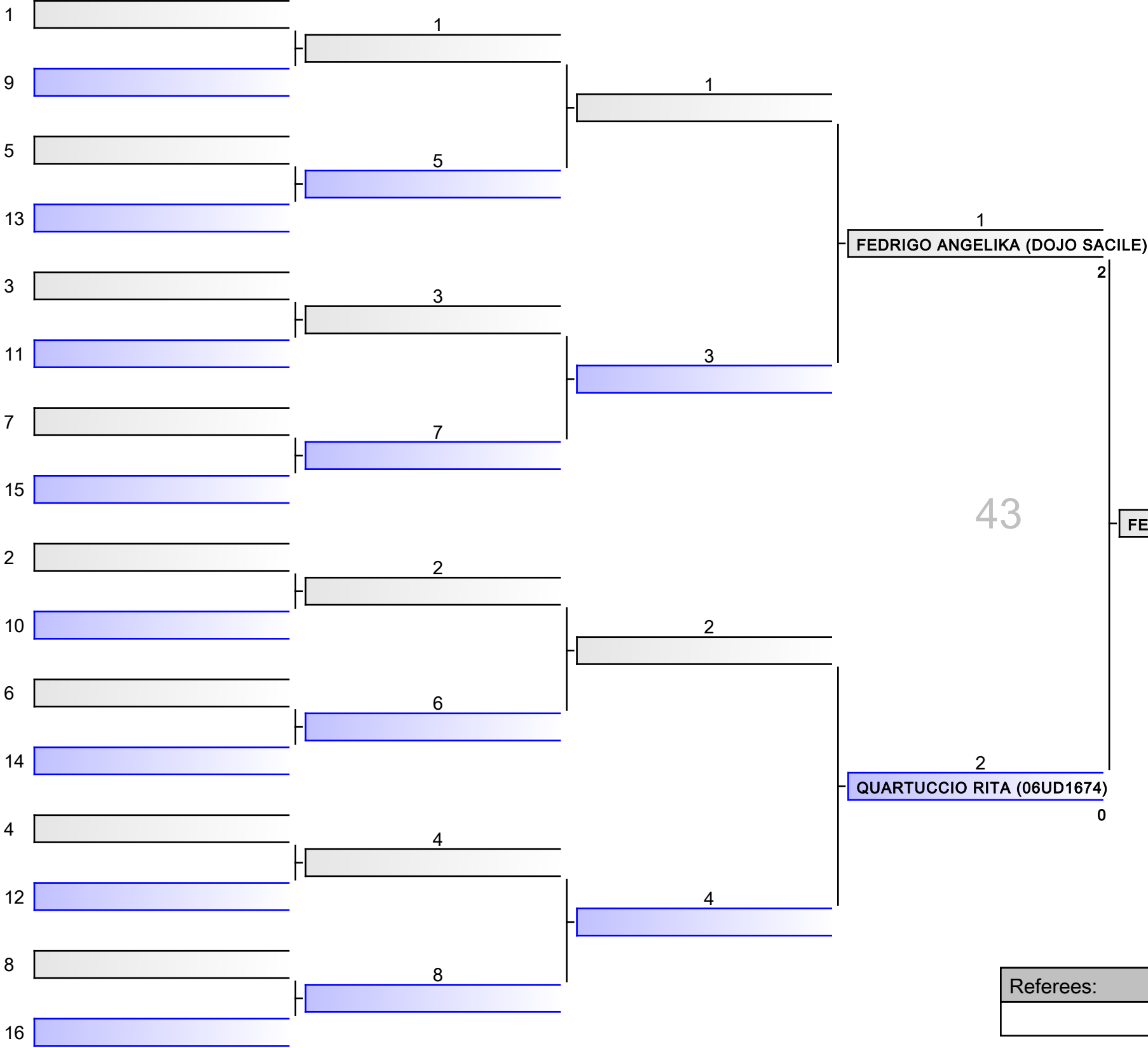

43

| |
|-----------------------------------|
| 1. FEDRIGO ANGELIKA (DOJO SACILE) |
| 2. QUARTUCCIO RITA (06UD1674) |
| |
| |
| |
| |
| |

| | | | |
|-----------|--|--|--|
| Referees: | | | |
| | | | |

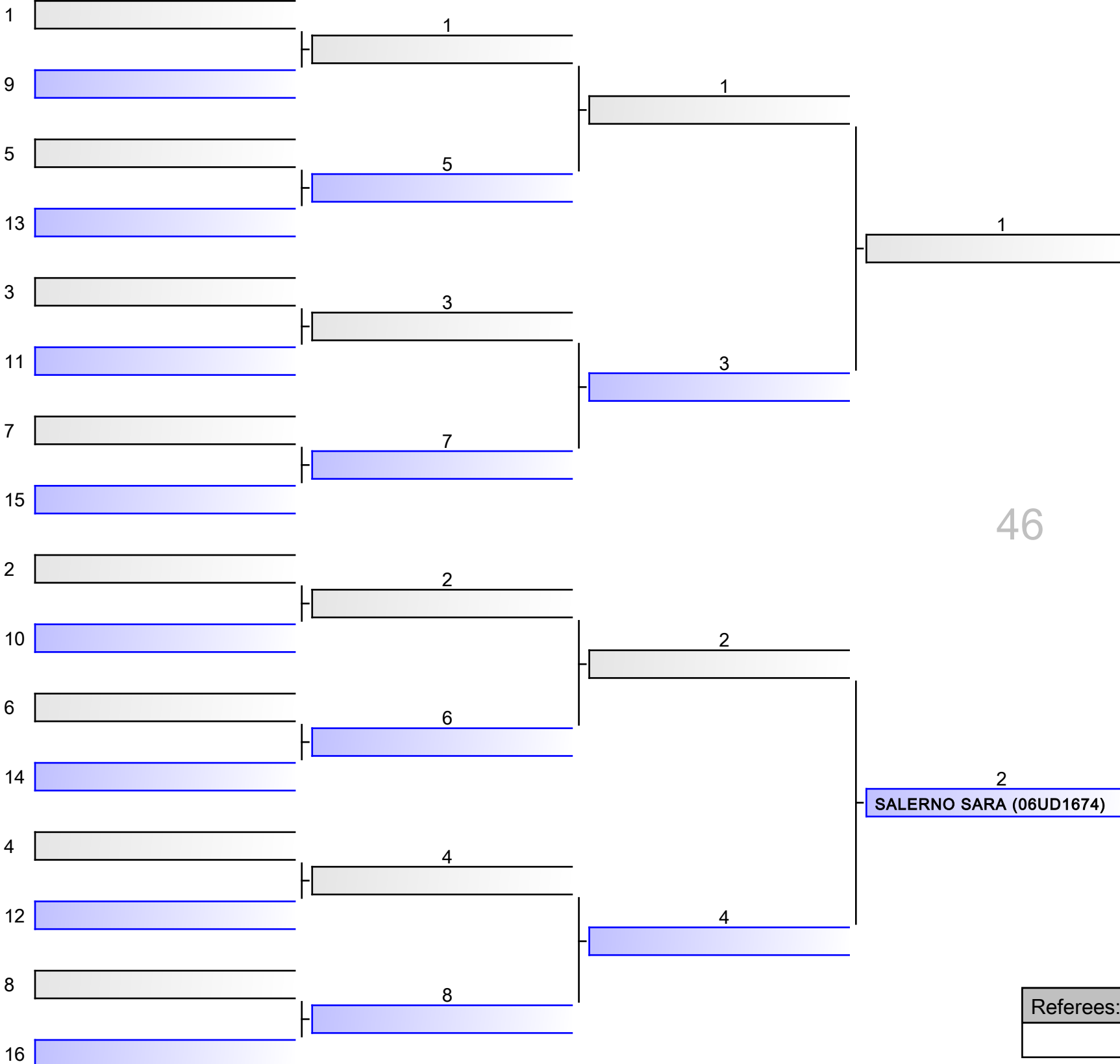

SALERNO SARA (06UD1674)

| |
|----------------------------|
| 1. SALERNO SARA (06UD1674) |
| |
| |
| |
| |
| |
| |
| |

| | | | |
|-----------|--|--|--|
| Referees: | | | |
| | | | |

U13 F -48 KG - Round Robin (each against each)

| | | | | |
|----|---------------------------------------|----|-----|---------------------------------------|
| 1 | FERRARI VERONICA (KYU SHIN DO KAI PR) | 49 | 100 | FERRARI VERONICA (KYU SHIN DO KAI PR) |
| 2 | TERENZANI GIOVANNA (06UD1674) | 0 | | |
| 3 | RUBERTI ROSSELLA (06TS3610) | 50 | 100 | RUBERTI ROSSELLA (06TS3610) |
| 4 | FERRARI VERONICA (KYU SHIN DO KAI PR) | 0 | | |
| 5 | TERENZANI GIOVANNA (06UD1674) | 51 | 0 | RUBERTI ROSSELLA (06TS3610) |
| 6 | RUBERTI ROSSELLA (06TS3610) | 2 | | |
| 7 | | | | |
| 8 | | | | |
| 9 | | | | |
| 10 | | | | |
| 11 | | | | |
| 12 | | | | |
| 13 | | | | |
| 14 | | | | |
| 15 | | | | |
| 16 | | | | |

| |
|--|
| 1. RUBERTI ROSSELLA (06TS3610) |
| 2. FERRARI VERONICA (KYU SHIN DO KAI PR) |
| 3. TERENZANI GIOVANNA (06UD1674) |
| |
| |
| |
| |

| | | | |
|-----------|--|--|--|
| Referees: | | | |
| | | | |

U13 F -57 KG - Round Robin (each against each)

Tatami

Pool
1/1

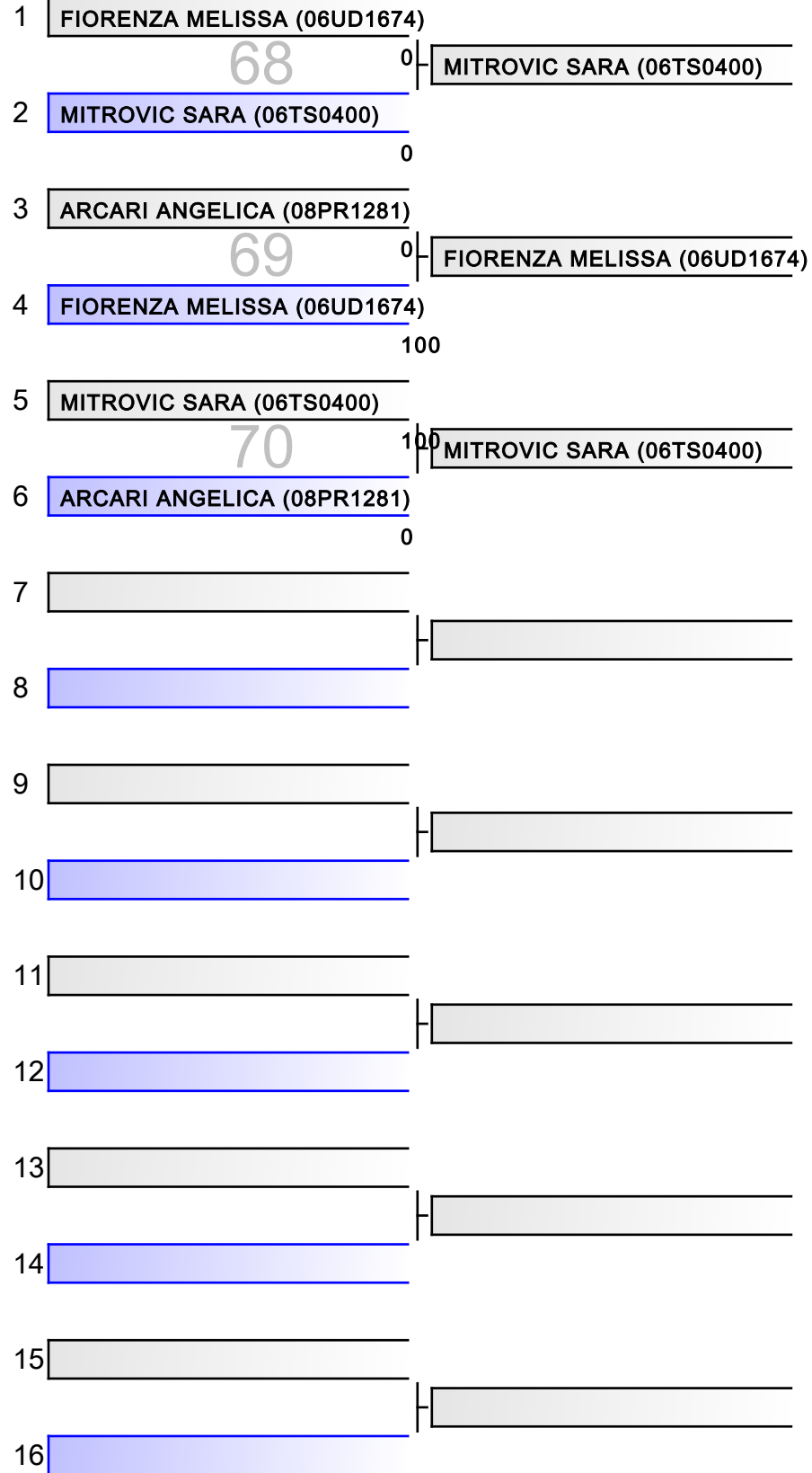

| |
|--------------------------------|
| 1. MITROVIC SARA (06TS0400) |
| 2. FIORENZA MELISSA (06UD1674) |
| 3. ARCARI ANGELICA (08PR1281) |
| |
| |
| |
| |

| | | | |
|-----------|--|--|--|
| Referees: | | | |
| | | | |

U13 M -36 KG

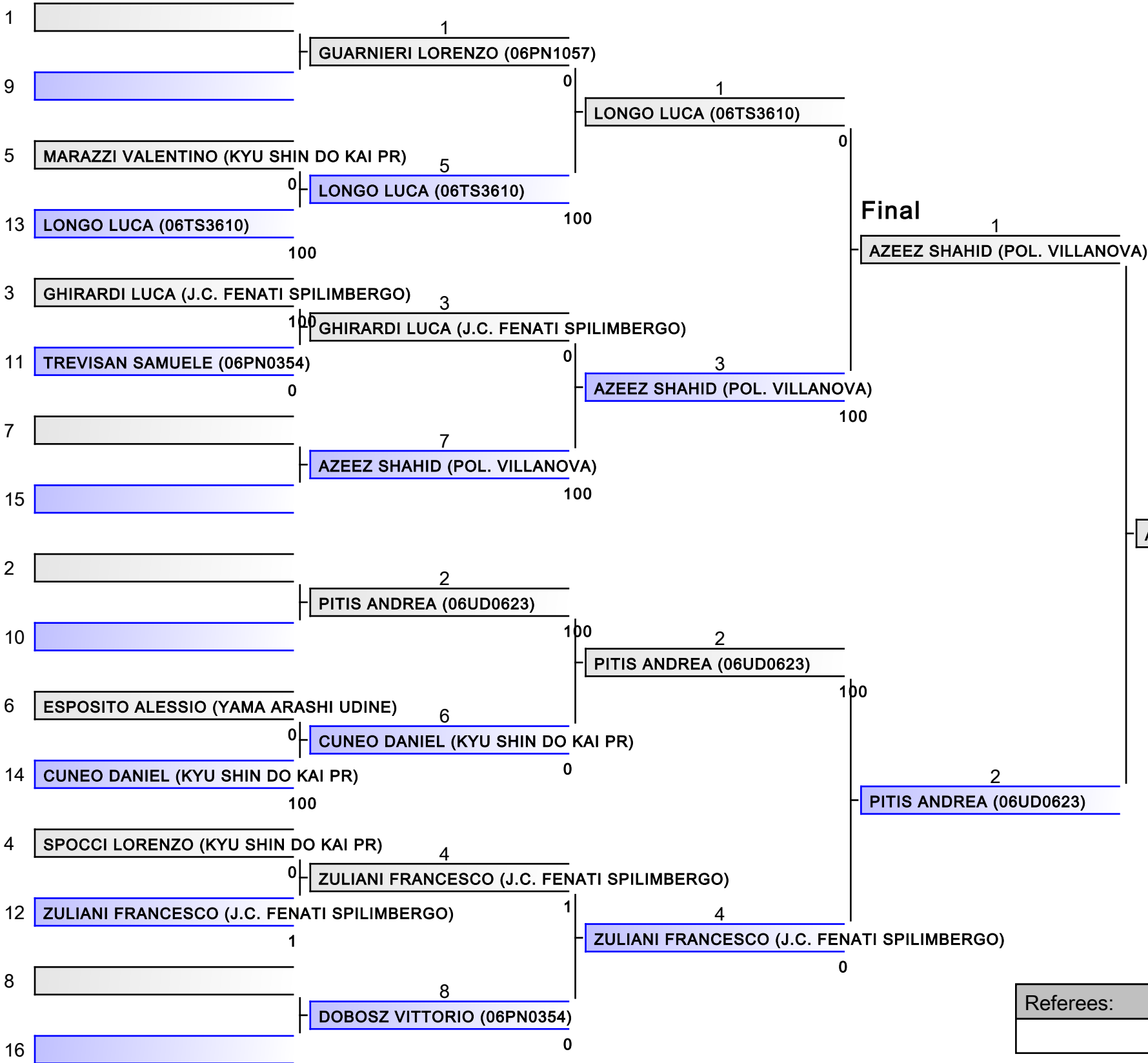

| |
|--|
| 1. AZEEZ SHAHID (POL. VILLANOVA) |
| 2. PITIS ANDREA (06UD0623) |
| 3. GUARNIERI LORENZO (06PN1057) |
| 3. LONGO LUCA (06TS3610) |
| 5. ZULIANI FRANCESCO (J.C. FENATI SPILIMBERGO) |
| 5. CUNEO DANIEL (KYU SHIN DO KAI PR) |
| 7. GHIRARDI LUCA (J.C. FENATI SPILIMBERGO) |
| 7. DOBOSZ VITTORIO (06PN0354) |

| | | | |
|-----------|--|--|--|
| Referees: | | | |
| | | | |

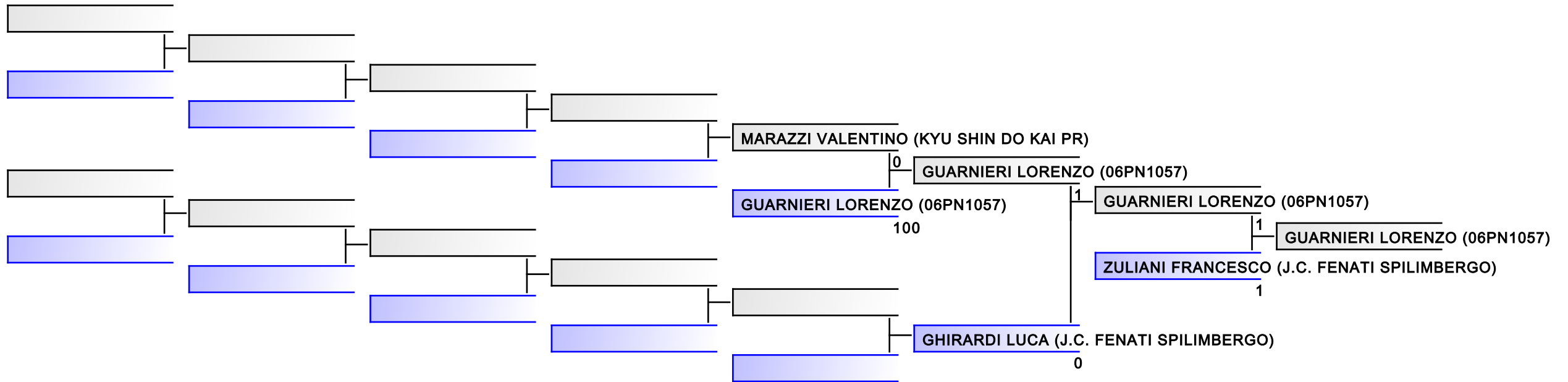

REPECHAGE: (1)

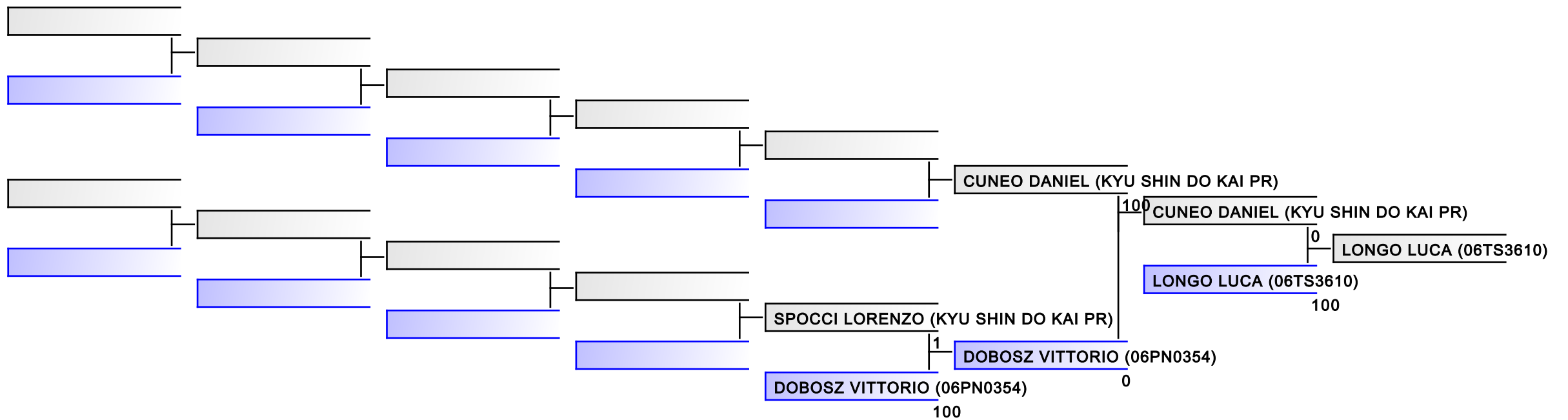

| | | | | | | | |
|-----------|--|--|--|--|--|--|--|
| Referees: | | | | | | | |
|-----------|--|--|--|--|--|--|--|

U13 M -40 KG

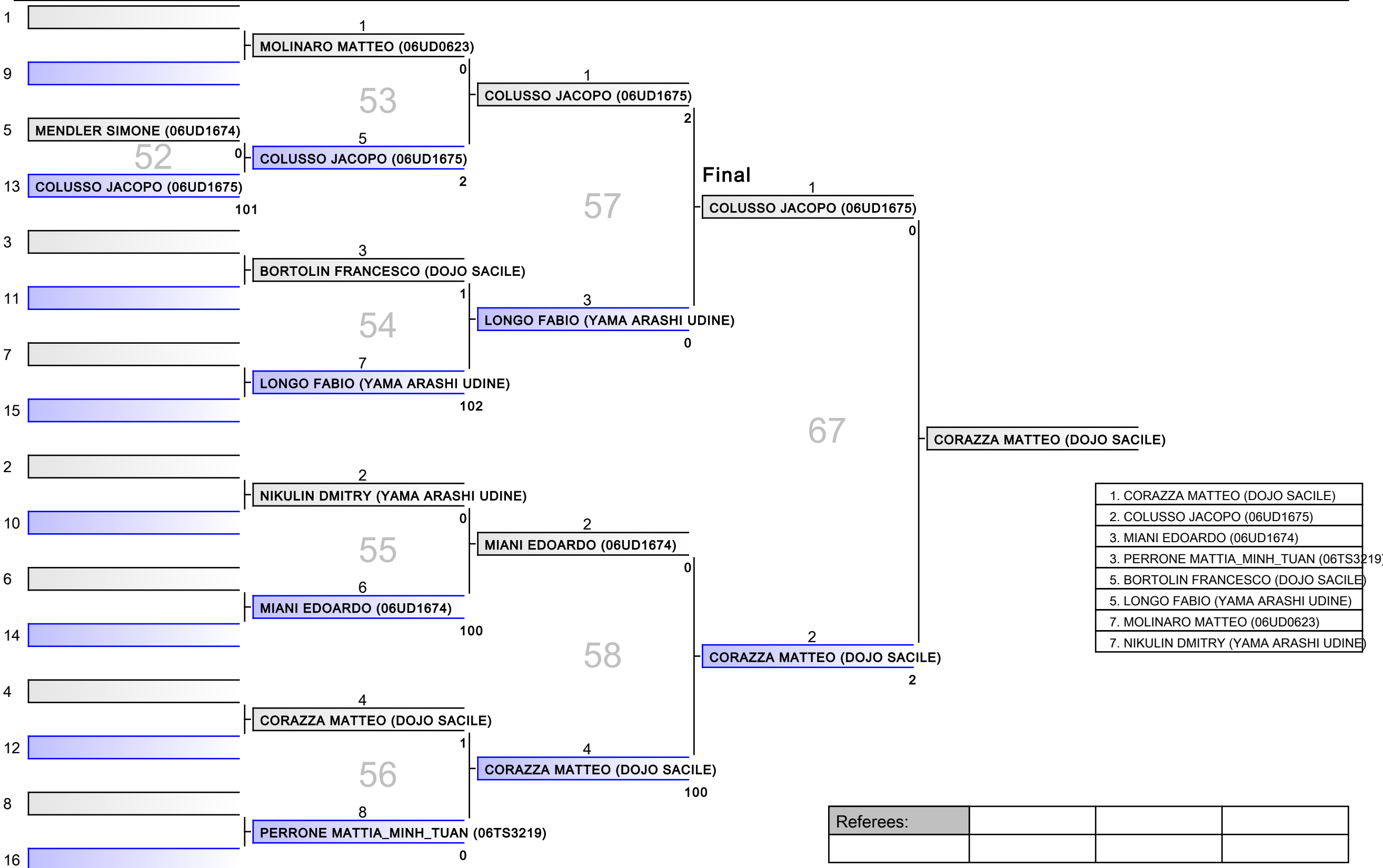

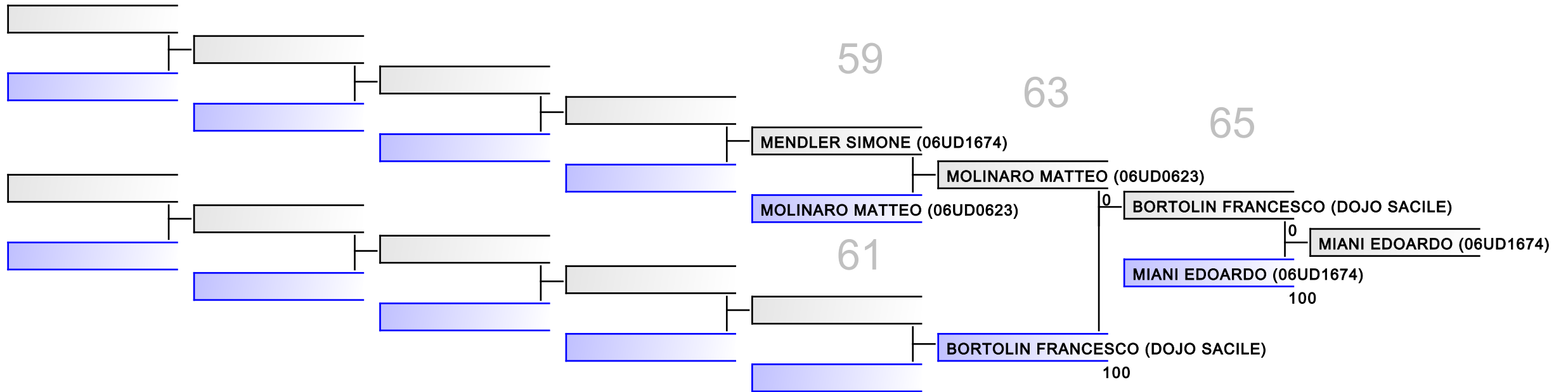

REPECHAGE: (1)

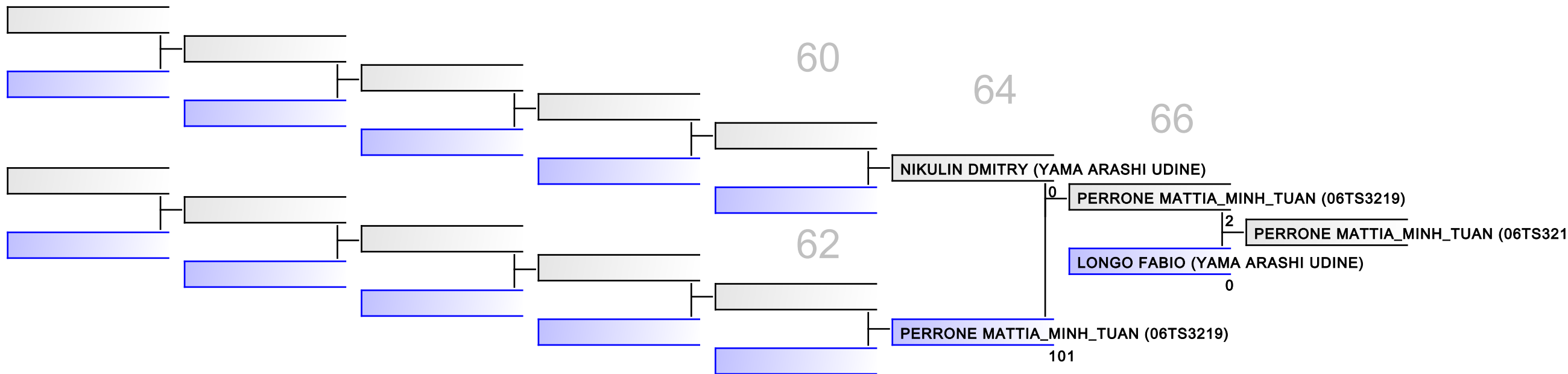

| | | | | | | | |
|-----------|--|--|--|--|--|--|--|
| Referees: | | | | | | | |
|-----------|--|--|--|--|--|--|--|

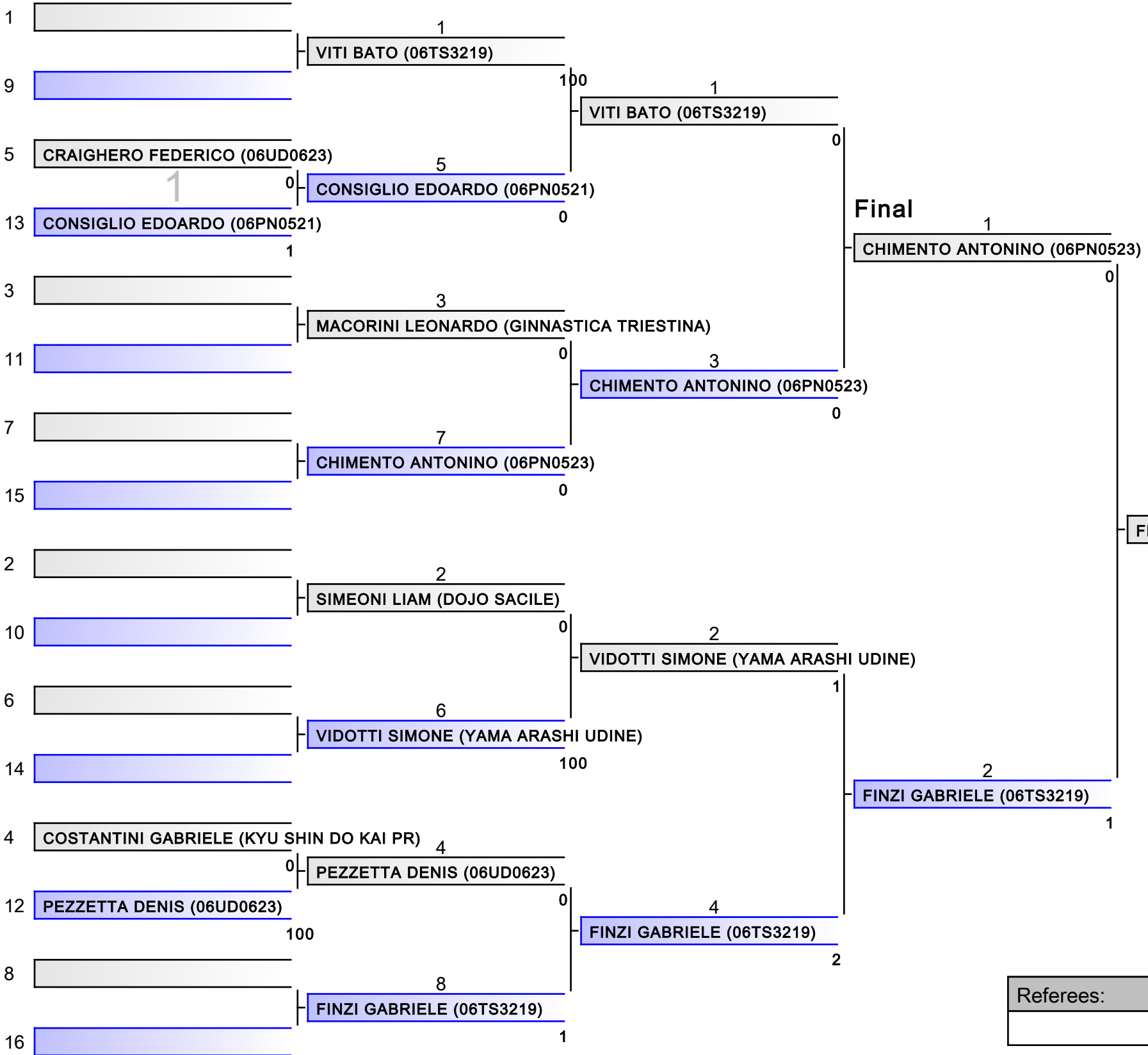

- | |
|---|
| 1. FINZI GABRIELE (06TS3219) |
| 2. CHIMENTO ANTONINO (06PN0523) |
| 3. PEZZETTA DENIS (06UD0623) |
| 3. VIDOTTI SIMONE (YAMA ARASHI UDINE) |
| 5. VITI BATO (06TS3219) |
| 5. CONSIGLIO EDOARDO (06PN0521) |
| 7. SIMEONI LIAM (DOJO SACILE) |
| 7. MACORINI LEONARDO (GINNASTICA TRIESTINA) |

| | | | |
|-----------|--|--|--|
| Referees: | | | |
| | | | |

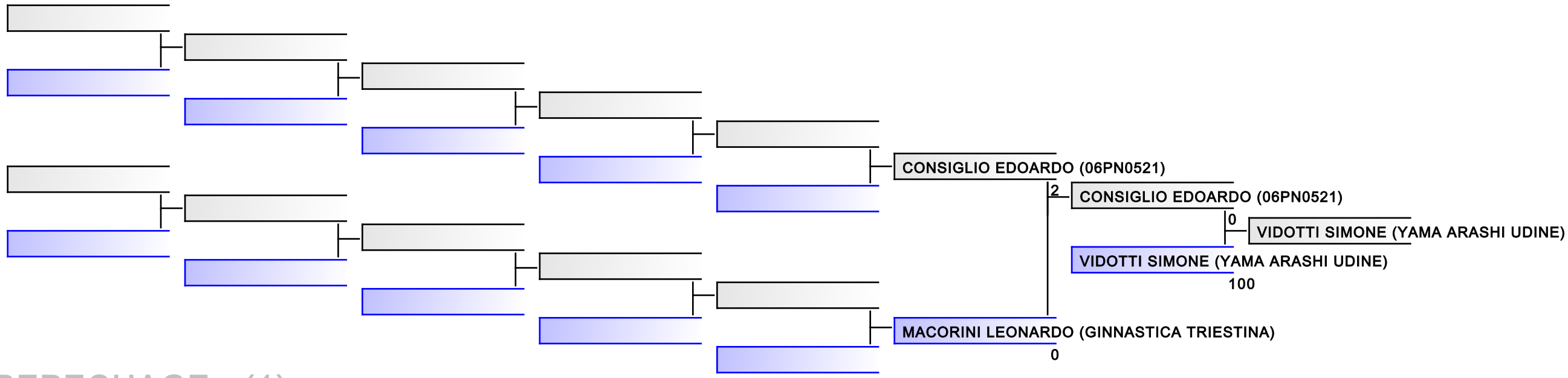

REPECHAGE: (1)

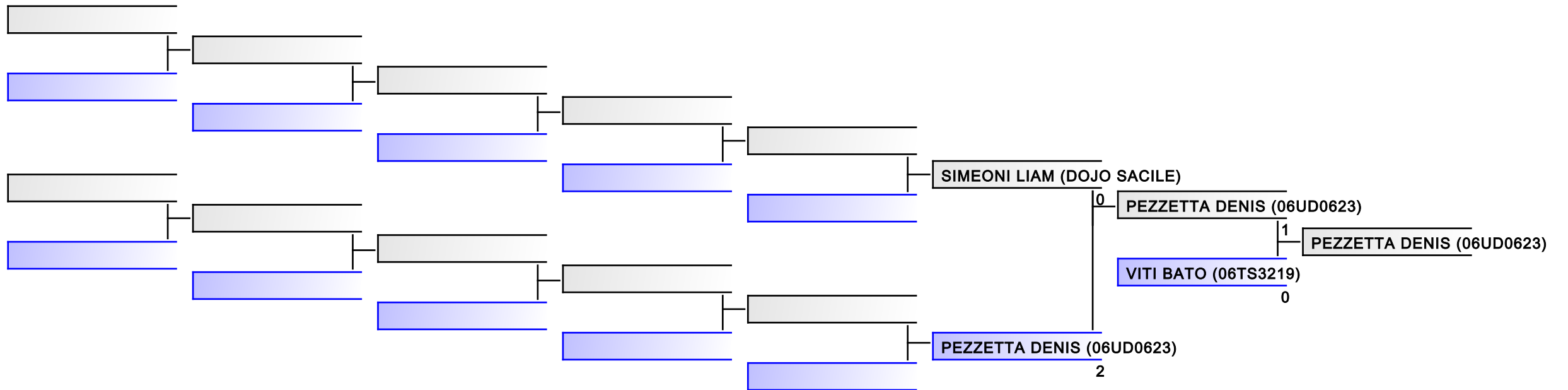

| | | | | | | | |
|-----------|--|--|--|--|--|--|--|
| Referees: | | | | | | | |
|-----------|--|--|--|--|--|--|--|

U13 M -50 KG

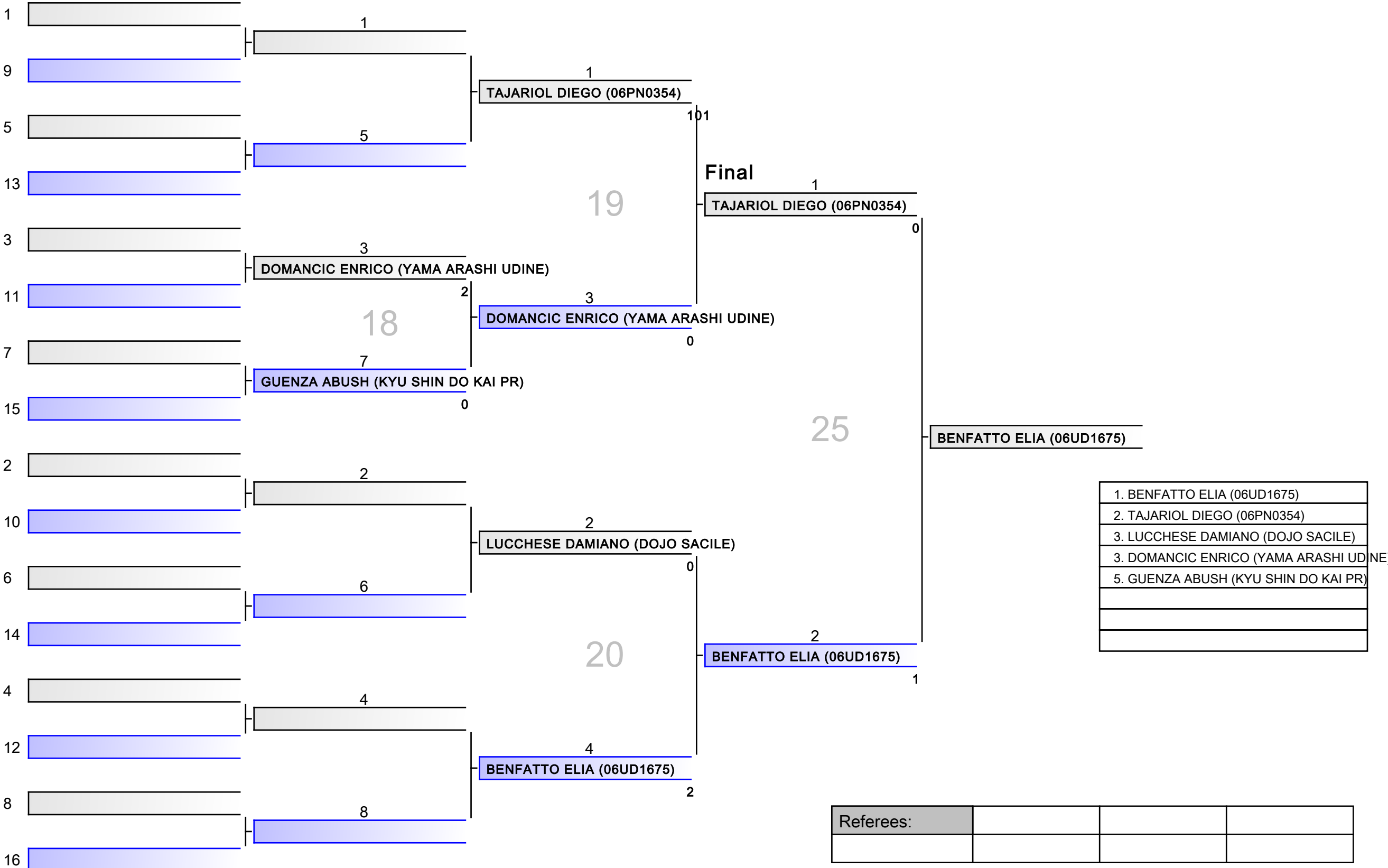

| | | | |
|-----------|--|--|--|
| Referees: | | | |
| | | | |

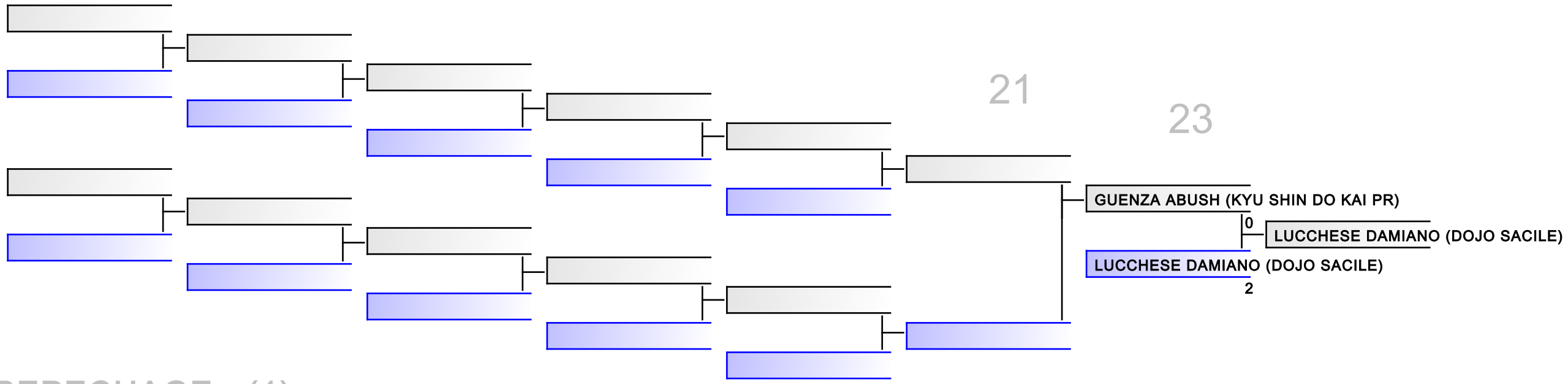

REPECHAGE: (1)

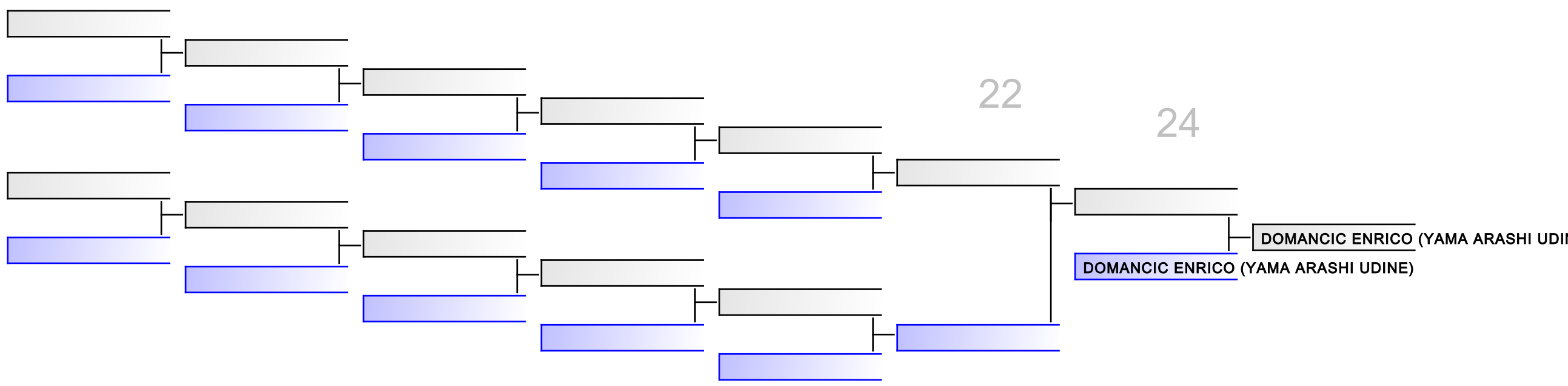

| | | | | | | | |
|-----------|--|--|--|--|--|--|--|
| Referees: | | | | | | | |
|-----------|--|--|--|--|--|--|--|

U13 M -55 KG

1/1

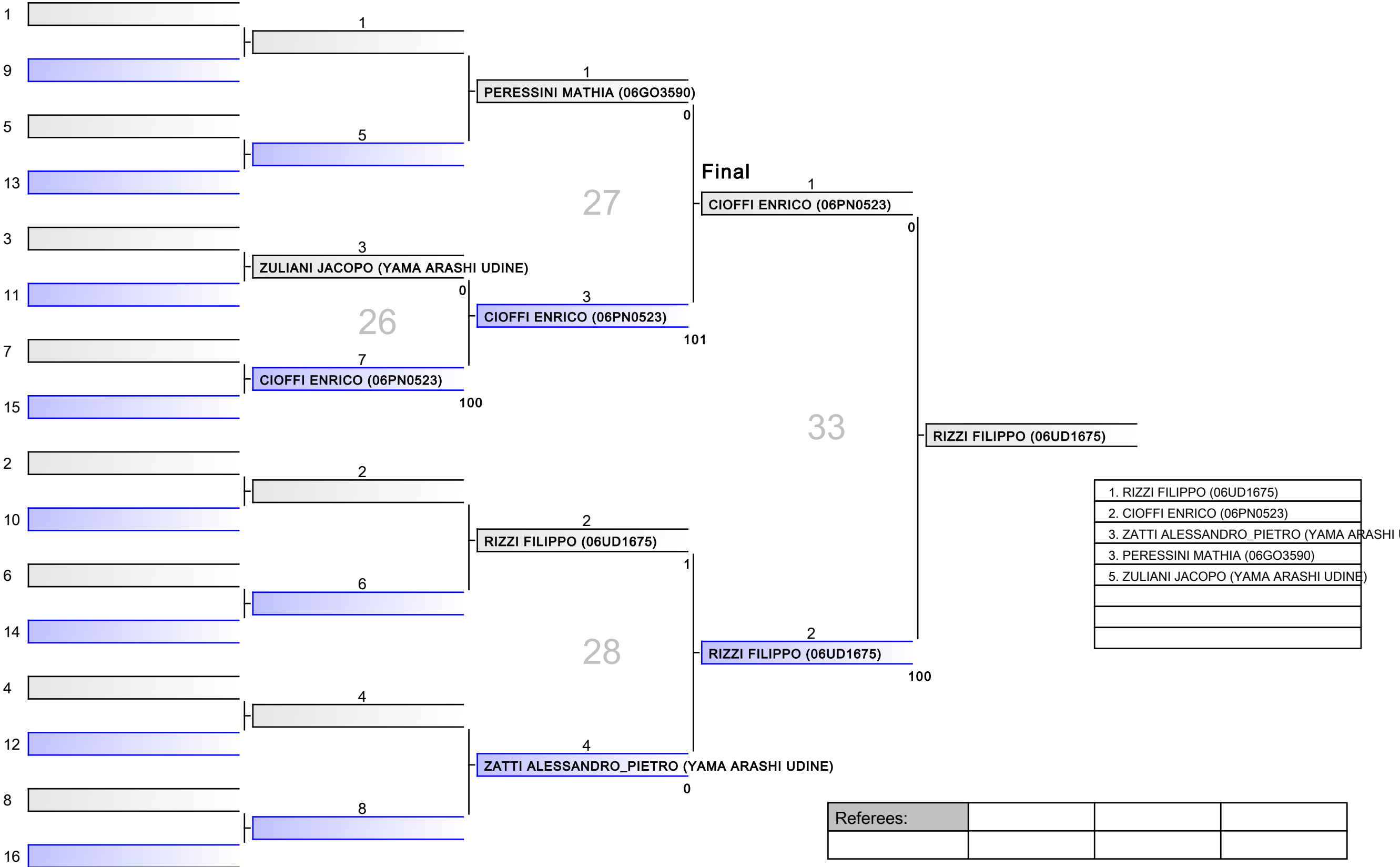

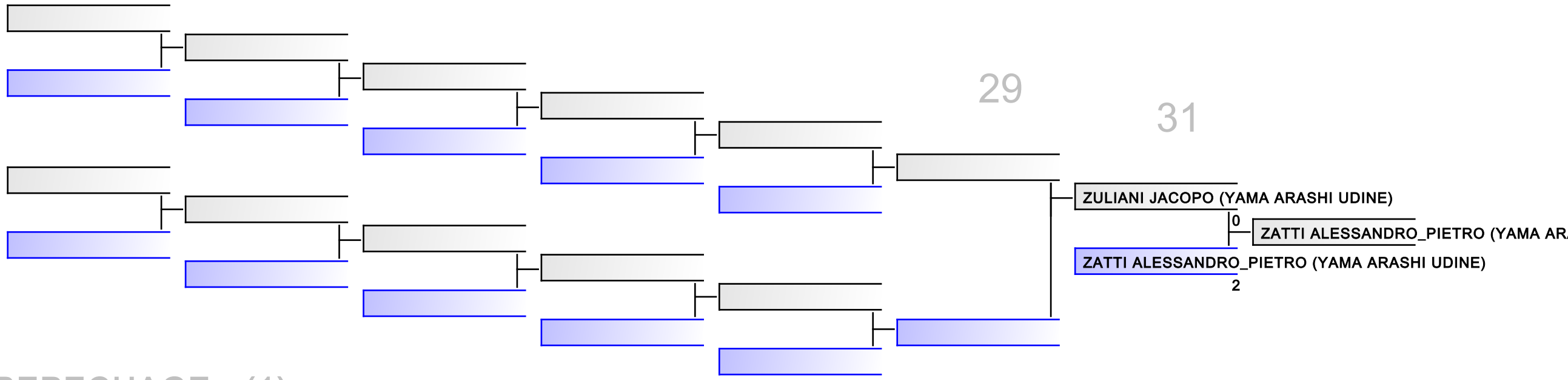

REPECHAGE: (1)

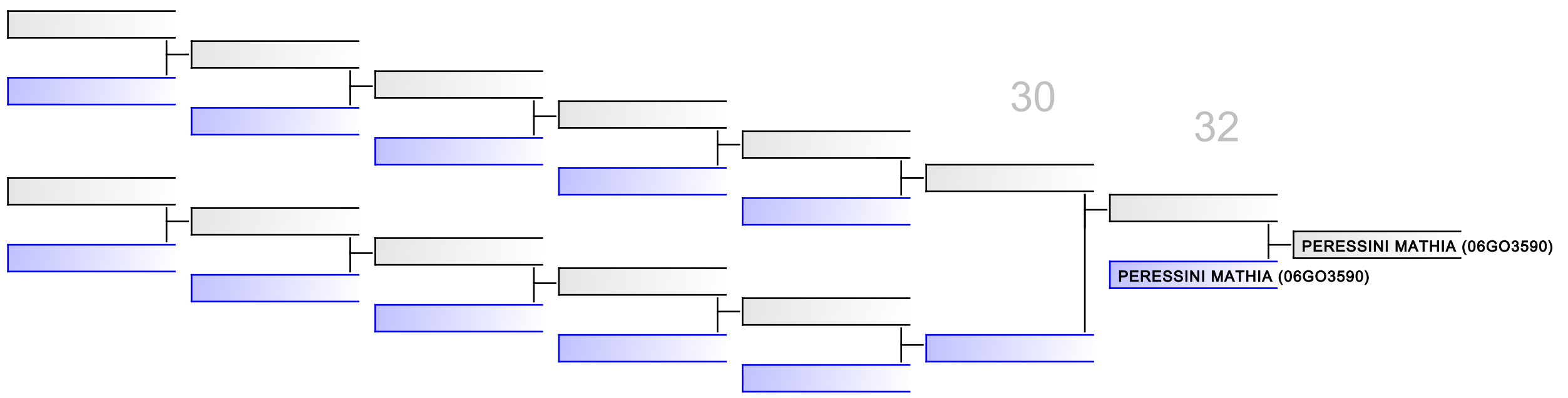

| | | | | | | | |
|-----------|--|--|--|--|--|--|--|
| Referees: | | | | | | | |
|-----------|--|--|--|--|--|--|--|

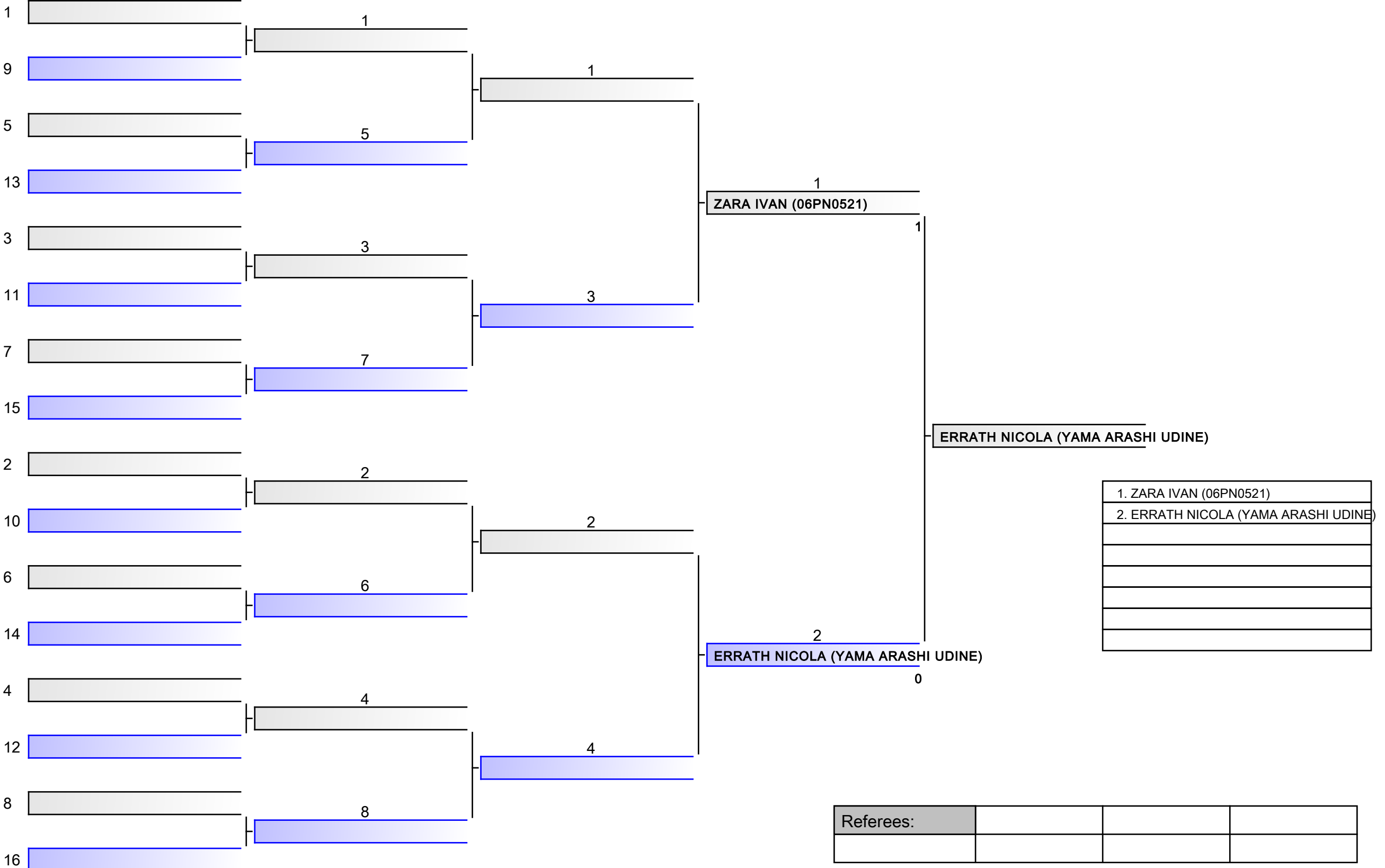

U13 M -66 KG - Round Robin (each against each)

Tatami

Pool
1/1

| | | | |
|----|---|-----|---|
| 1 | HADENKO VITALII (J.C. FENATI SPILIMBERGO) | 0 | ROS CRTISTIAN (06PN1057) |
| 2 | ROS CRTISTIAN (06PN1057) | 1 | |
| 3 | DI_GENNARO MASSIMO (GINNASTICA TRIESTINA) | 100 | DI_GENNARO MASSIMO (GINNASTICA TRIESTINA) |
| 4 | HADENKO VITALII (J.C. FENATI SPILIMBERGO) | 0 | |
| 5 | ROS CRTISTIAN (06PN1057) | 0 | DI_GENNARO MASSIMO (GINNASTICA TRIESTINA) |
| 6 | DI_GENNARO MASSIMO (GINNASTICA TRIESTINA) | 100 | |
| 7 | | | |
| 8 | | | |
| 9 | | | |
| 10 | | | |
| 11 | | | |
| 12 | | | |
| 13 | | | |
| 14 | | | |
| 15 | | | |
| 16 | | | |

| |
|--|
| 1. DI_GENNARO MASSIMO (GINNASTICA TRIESTINA) |
| 2. ROS CRTISTIAN (06PN1057) |
| 3. HADENKO VITALII (J.C. FENATI SPILIMBERGO) |
| |
| |
| |
| |

| | | | |
|-----------|--|--|--|
| Referees: | | | |
| | | | |

U15 F -44 KG - Round Robin (each against each)

| | | | | |
|----|--------------------------------|----|---|--------------------------------|
| 1 | CIROI LISA (YAMA ARASHI UDINE) | 71 | 0 | LO_GATTO FABIOLA (06UD1674) |
| 2 | LO_GATTO FABIOLA (06UD1674) | | 2 | |
| 3 | FUMO ANNA_LUCIA (06UD1674) | 72 | 1 | CIROI LISA (YAMA ARASHI UDINE) |
| 4 | CIROI LISA (YAMA ARASHI UDINE) | | 2 | |
| 5 | LO_GATTO FABIOLA (06UD1674) | 73 | 2 | LO_GATTO FABIOLA (06UD1674) |
| 6 | FUMO ANNA_LUCIA (06UD1674) | | 0 | |
| 7 | | | | |
| 8 | | | | |
| 9 | | | | |
| 10 | | | | |
| 11 | | | | |
| 12 | | | | |
| 13 | | | | |
| 14 | | | | |
| 15 | | | | |
| 16 | | | | |

| |
|-----------------------------------|
| 1. LO_GATTO FABIOLA (06UD1674) |
| 2. CIROI LISA (YAMA ARASHI UDINE) |
| 3. FUMO ANNA_LUCIA (06UD1674) |
| |
| |
| |
| |

| | | | |
|-----------|--|--|--|
| Referees: | | | |
| | | | |

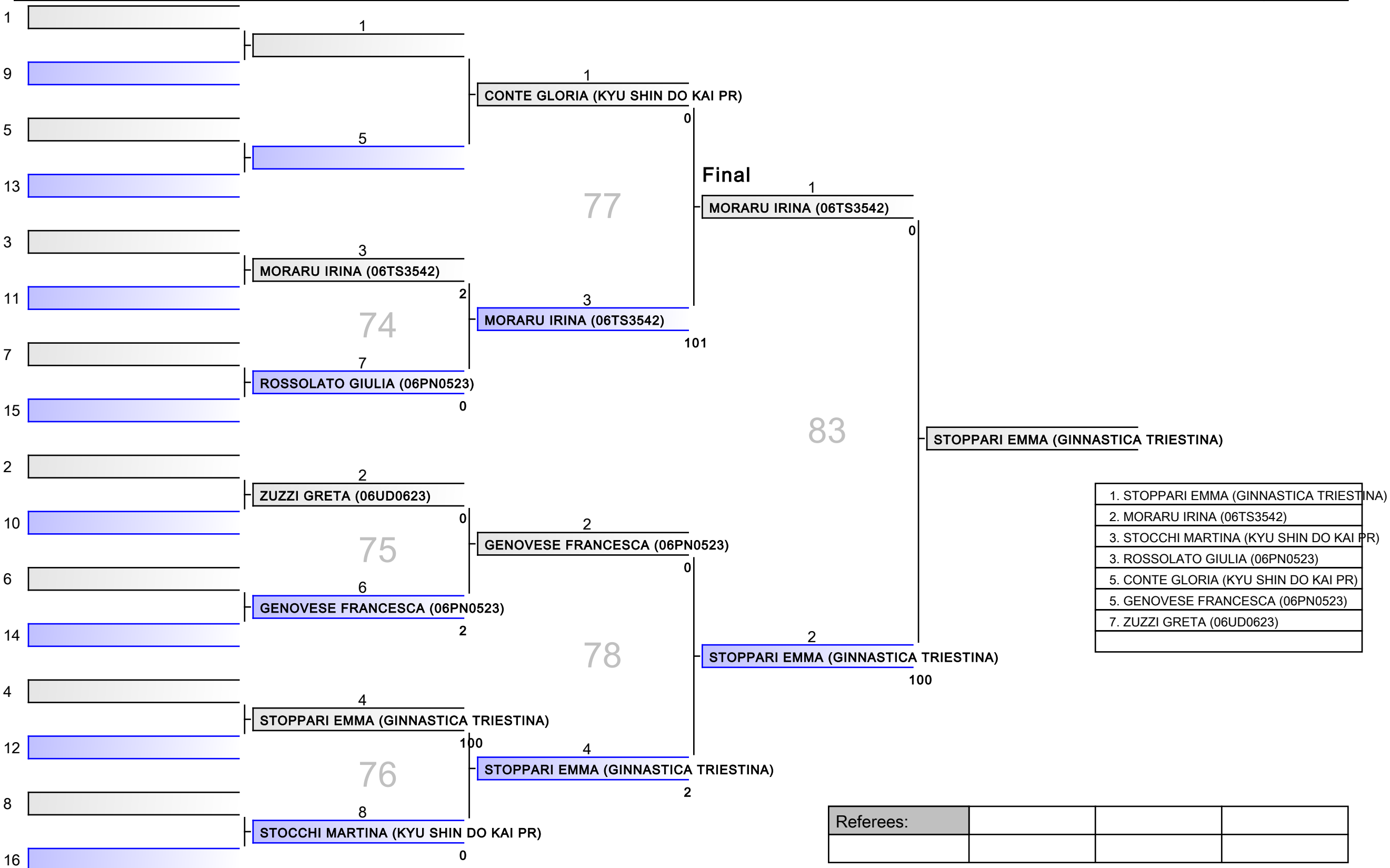

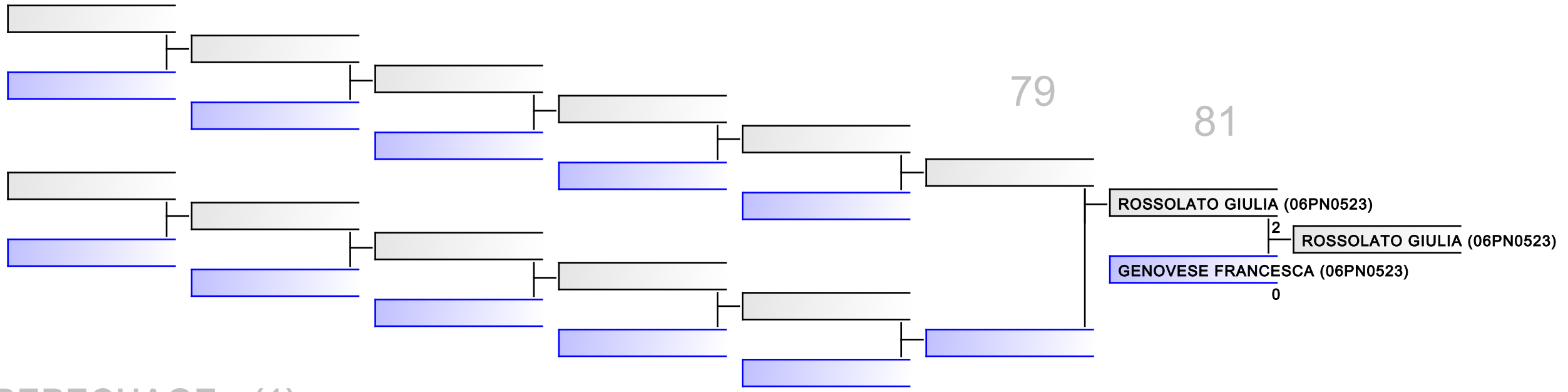

REPECHAGE: (1)

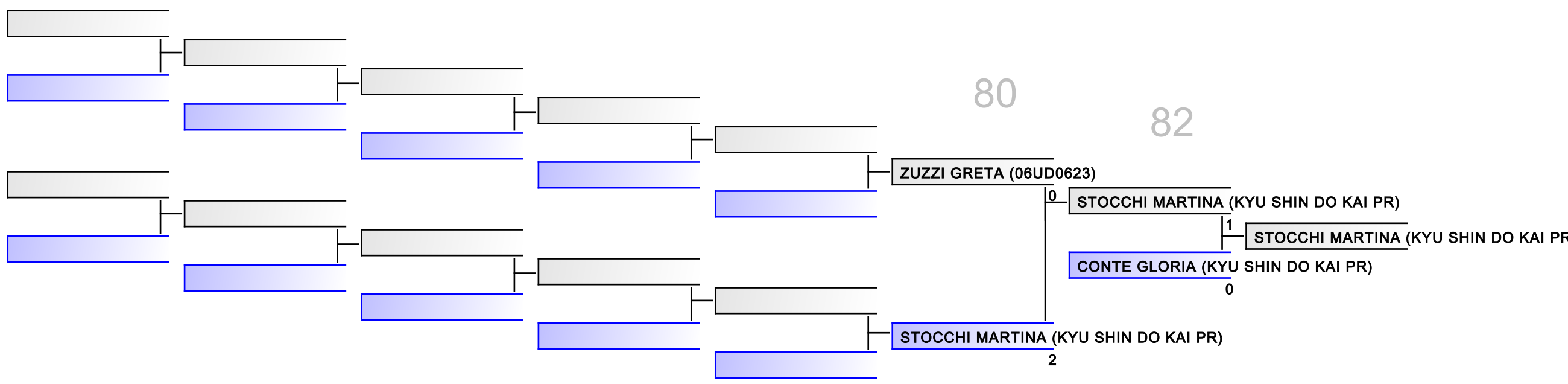

| | | | | | | | |
|-----------|--|--|--|--|--|--|--|
| Referees: | | | | | | | |
|-----------|--|--|--|--|--|--|--|

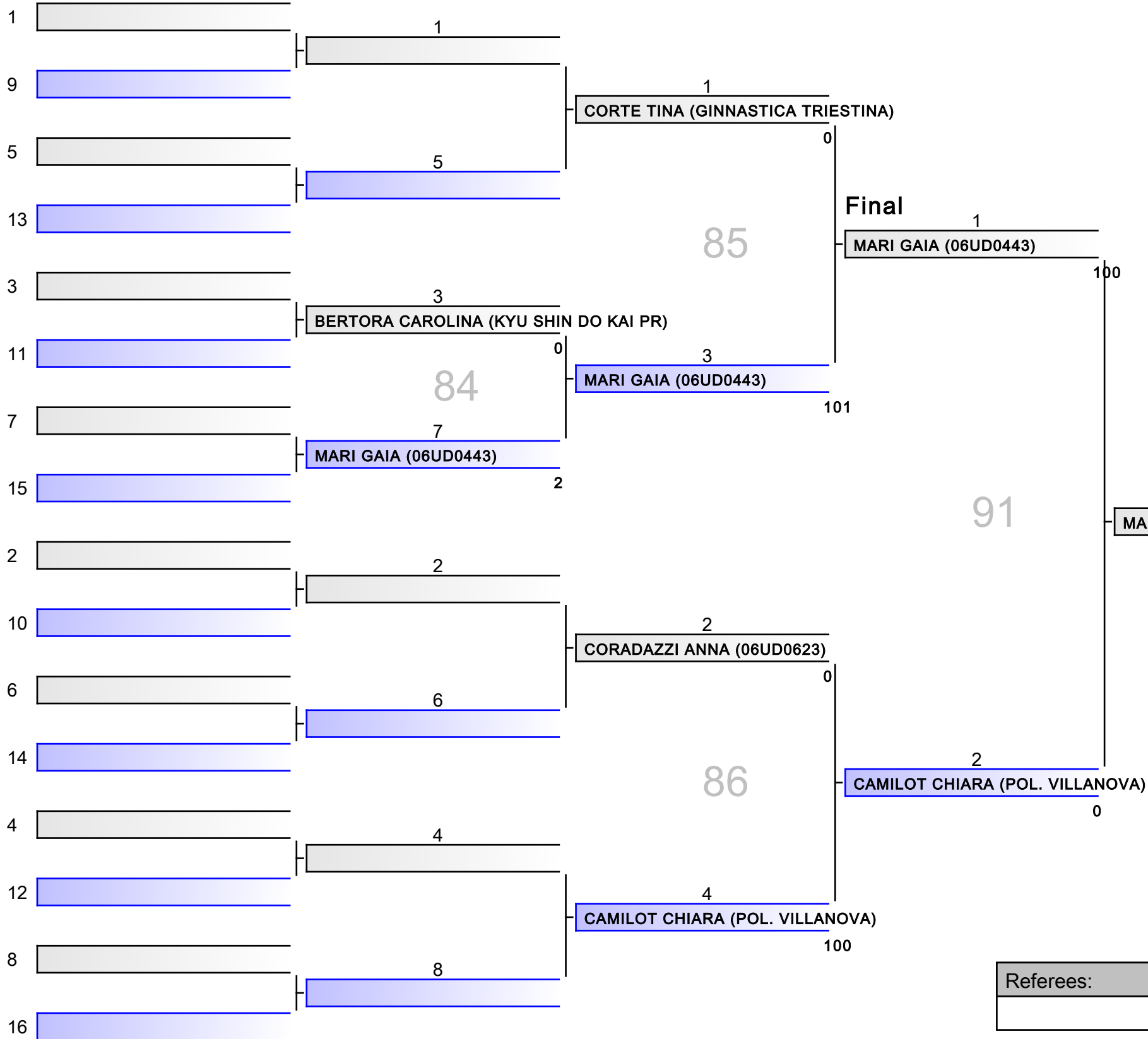

| |
|--|
| 1. MARI GAIA (06UD0443) |
| 2. CAMILOT CHIARA (POL. VILLANOVA) |
| 3. BERTORA CAROLINA (KYU SHIN DO KAI PR) |
| 3. CORTE TINA (GINNASTICA TRIESTINA) |
| 5. CORADAZZI ANNA (06UD0623) |
| |
| |

| | | | |
|-----------|--|--|--|
| Referees: | | | |
| | | | |

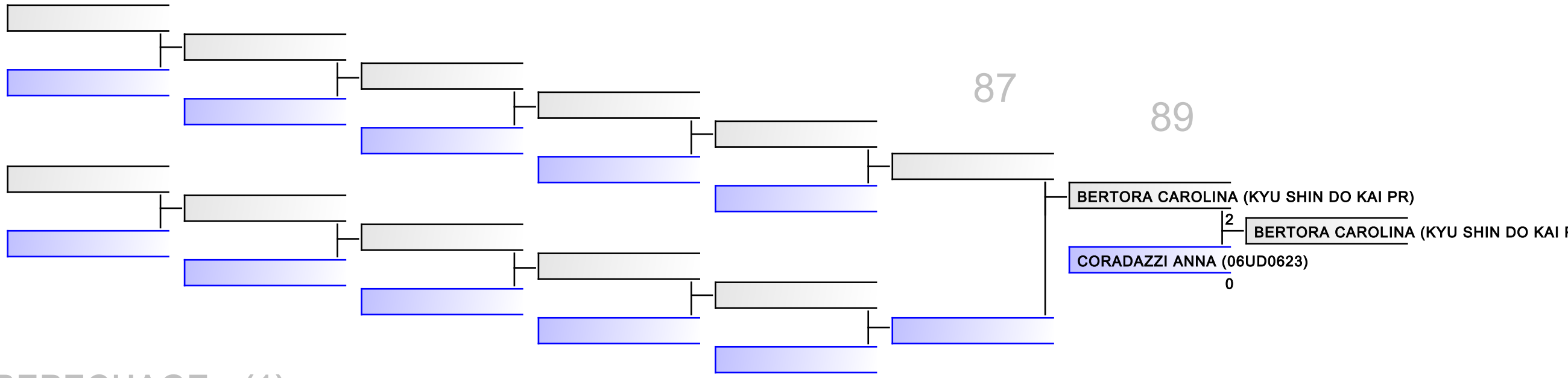

REPECHAGE: (1)

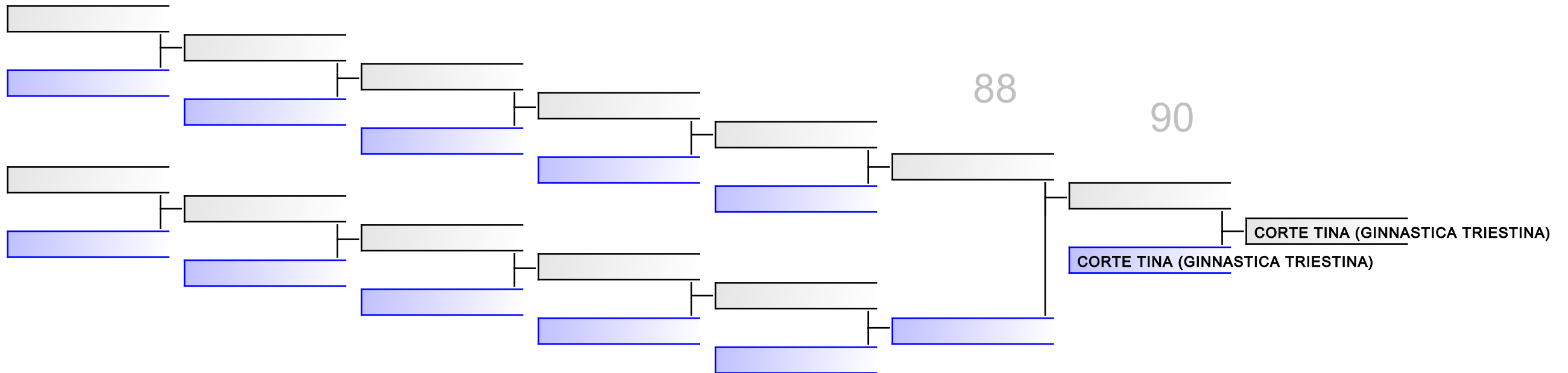

| | | | | | | | |
|-----------|--|--|--|--|--|--|--|
| Referees: | | | | | | | |
|-----------|--|--|--|--|--|--|--|

U15 F -57 KG - Round Robin (each against each)

| | | | | |
|----|--|----|-----|--|
| 1 | ROMANIN ARIANNA (GINNASTICA TRIESTINA) | 92 | 2 | ROMANIN ARIANNA (GINNASTICA TRIESTINA) |
| 2 | GAMBETTA ANNALISA (KYU SHIN DO KAI PR) | 0 | | |
| 3 | GRECO GLORIA (GINNASTICA TRIESTINA) | 93 | 100 | GRECO GLORIA (GINNASTICA TRIESTINA) |
| 4 | COSENZA ILARIA (06UD0623) | 0 | | |
| 5 | GRECO GLORIA (GINNASTICA TRIESTINA) | 94 | 0 | ROMANIN ARIANNA (GINNASTICA TRIESTINA) |
| 6 | ROMANIN ARIANNA (GINNASTICA TRIESTINA) | 1 | | |
| 7 | COSENZA ILARIA (06UD0623) | 95 | 1 | COSENZA ILARIA (06UD0623) |
| 8 | GAMBETTA ANNALISA (KYU SHIN DO KAI PR) | 0 | | |
| 9 | ROMANIN ARIANNA (GINNASTICA TRIESTINA) | 96 | 100 | ROMANIN ARIANNA (GINNASTICA TRIESTINA) |
| 10 | COSENZA ILARIA (06UD0623) | 0 | | |
| 11 | GAMBETTA ANNALISA (KYU SHIN DO KAI PR) | 97 | 2 | GAMBETTA ANNALISA (KYU SHIN DO KAI PR) |
| 12 | GRECO GLORIA (GINNASTICA TRIESTINA) | 1 | | |
| 13 | | | | |
| 14 | | | | |
| 15 | | | | |
| 16 | | | | |

| |
|---|
| 1. ROMANIN ARIANNA (GINNASTICA TRIESTINA) |
| 2. GRECO GLORIA (GINNASTICA TRIESTINA) |
| 3. GAMBETTA ANNALISA (KYU SHIN DO KAI PR) |
| 4. COSENZA ILARIA (06UD0623) |
| |
| |
| |

| | | | |
|-----------|--|--|--|
| Referees: | | | |
| | | | |

U15 F -63 KG - Round Robin (each against each)

1/1

| | | | | |
|----|------------------------------------|-----|-----|------------------------------------|
| 1 | CASTELLANI EVA (YAMA ARASHI UDINE) | 117 | 100 | CASTELLANI EVA (YAMA ARASHI UDINE) |
| 2 | ZILIOLI CAROLINA_ELISA (06PN1057) | 0 | | |
| 3 | PERISSINOTTO SILVIA (06UD1674) | 118 | 0 | ALZETTA IOLE (06PN0523) |
| 4 | ALZETTA IOLE (06PN0523) | 101 | | |
| 5 | PERISSINOTTO SILVIA (06UD1674) | 119 | 0 | CASTELLANI EVA (YAMA ARASHI UDINE) |
| 6 | CASTELLANI EVA (YAMA ARASHI UDINE) | 100 | | |
| 7 | ALZETTA IOLE (06PN0523) | 120 | 100 | ALZETTA IOLE (06PN0523) |
| 8 | ZILIOLI CAROLINA_ELISA (06PN1057) | 0 | | |
| 9 | CASTELLANI EVA (YAMA ARASHI UDINE) | 121 | 0 | ALZETTA IOLE (06PN0523) |
| 10 | ALZETTA IOLE (06PN0523) | 2 | | |
| 11 | ZILIOLI CAROLINA_ELISA (06PN1057) | 122 | 0 | PERISSINOTTO SILVIA (06UD1674) |
| 12 | PERISSINOTTO SILVIA (06UD1674) | 2 | | |
| 13 | | | | |
| 14 | | | | |
| 15 | | | | |
| 16 | | | | |

| |
|---------------------------------------|
| 1. ALZETTA IOLE (06PN0523) |
| 2. CASTELLANI EVA (YAMA ARASHI UDINE) |
| 3. PERISSINOTTO SILVIA (06UD1674) |
| 4. ZILIOLI CAROLINA_ELISA (06PN1057) |
| |
| |
| |

| | | | |
|-----------|--|--|--|
| Referees: | | | |
| | | | |

U15 F -70 KG - Round Robin (each against each)

1/1

| | | | |
|----|------------------------------------|-----|------------------------------------|
| 1 | BORTOLIN MARIANNA (POL. VILLANOVA) | 100 | BORTOLIN MARIANNA (POL. VILLANOVA) |
| | 123 | | |
| 2 | BATTISTELLA ZAIRA (06PN0354) | 0 | |
| 3 | PIANI SOFIA (ISAO) | 2 | PIANI SOFIA (ISAO) |
| | 124 | | |
| 4 | BORTOLIN MARIANNA (POL. VILLANOVA) | 0 | |
| 5 | BATTISTELLA ZAIRA (06PN0354) | 0 | PIANI SOFIA (ISAO) |
| | 125 | | |
| 6 | PIANI SOFIA (ISAO) | 100 | |
| 7 | | | |
| 8 | | | |
| 9 | | | |
| 10 | | | |
| 11 | | | |
| 12 | | | |
| 13 | | | |
| 14 | | | |
| 15 | | | |
| 16 | | | |

| |
|---------------------------------------|
| 1. PIANI SOFIA (ISAO) |
| 2. BORTOLIN MARIANNA (POL. VILLANOVA) |
| 3. BATTISTELLA ZAIRA (06PN0354) |
| |
| |
| |
| |

| | | | |
|-----------|--|--|--|
| Referees: | | | |
| | | | |

U15 M -42 KG

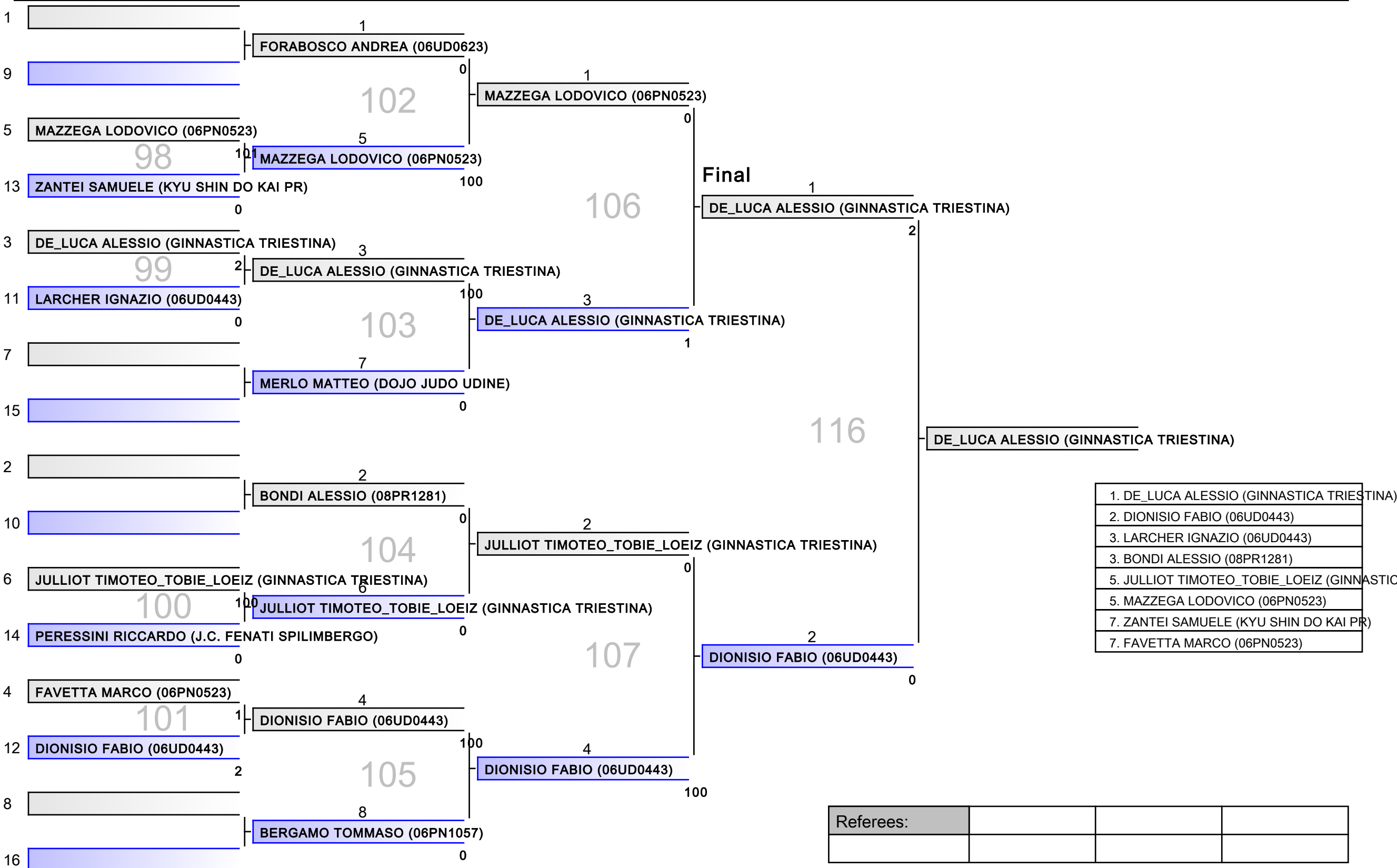

| |
|---|
| 1. DE_LUCA ALESSIO (GINNASTICA TRIESTINA) |
| 2. DIONISIO FABIO (06UD0443) |
| 3. LARCHER IGNAZIO (06UD0443) |
| 3. BONDI ALESSIO (08PR1281) |
| 5. JULLIOT TIMOTEO_TOBIE_LOEIZ (GINNASTICA TRIESTINA) |
| 5. MAZZEGA LODOVICO (06PN0523) |
| 7. ZANTEI SAMUELE (KYU SHIN DO KAI PR) |
| 7. FAVETTA MARCO (06PN0523) |

| | | | |
|-----------|--|--|--|
| Referees: | | | |
| | | | |

U15 M -46 KG - Round Robin (each against each)

| | | | | |
|----|--|-----|-----|--|
| 1 | MENNILLO ALESSANDRO (KYU SHIN DO KAI PR) | 126 | 0 | MEDAU LUCAS (GINNASTICA TRIESTINA) |
| 2 | MEDAU LUCAS (GINNASTICA TRIESTINA) | 101 | | |
| 3 | CASULA MATTEO (YAMA ARASHI UDINE) | 127 | 0 | MENNILLO ALESSANDRO (KYU SHIN DO KAI PR) |
| 4 | MENNILLO ALESSANDRO (KYU SHIN DO KAI PR) | 100 | | |
| 5 | MEDAU LUCAS (GINNASTICA TRIESTINA) | 128 | 100 | MEDAU LUCAS (GINNASTICA TRIESTINA) |
| 6 | CASULA MATTEO (YAMA ARASHI UDINE) | 0 | | |
| 7 | | | | |
| 8 | | | | |
| 9 | | | | |
| 10 | | | | |
| 11 | | | | |
| 12 | | | | |
| 13 | | | | |
| 14 | | | | |
| 15 | | | | |
| 16 | | | | |

| |
|---|
| 1. MEDAU LUCAS (GINNASTICA TRIESTINA) |
| 2. MENNILLO ALESSANDRO (KYU SHIN DO KAI P |
| 3. CASULA MATTEO (YAMA ARASHI UDINE) |
| |
| |
| |
| |

| | | | |
|-----------|--|--|--|
| Referees: | | | |
| | | | |

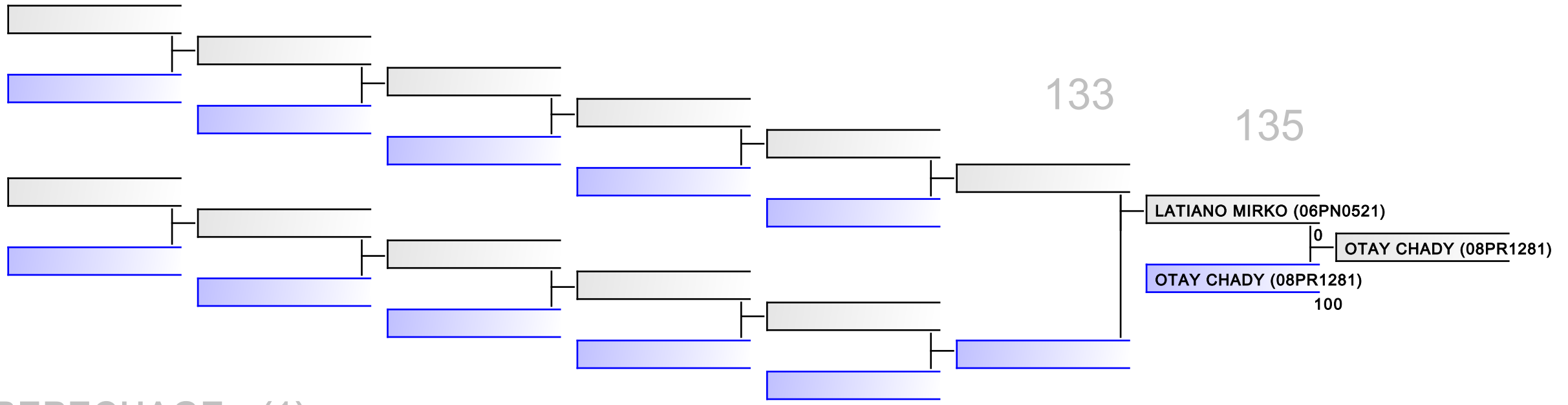

REPECHAGE: (1)

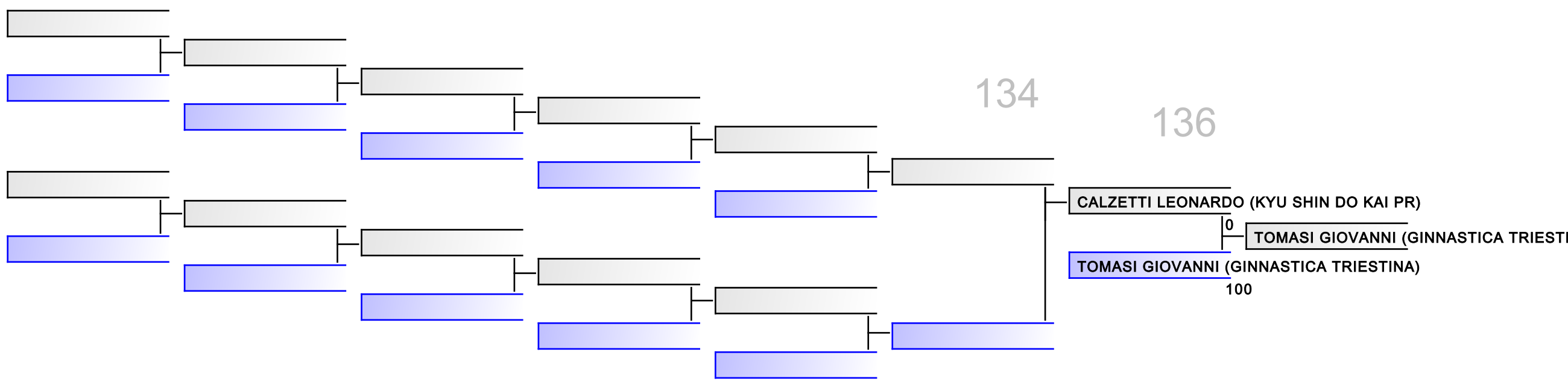

| | | | | | | | |
|-----------|--|--|--|--|--|--|--|
| Referees: | | | | | | | |
|-----------|--|--|--|--|--|--|--|

U15 M -42 KG

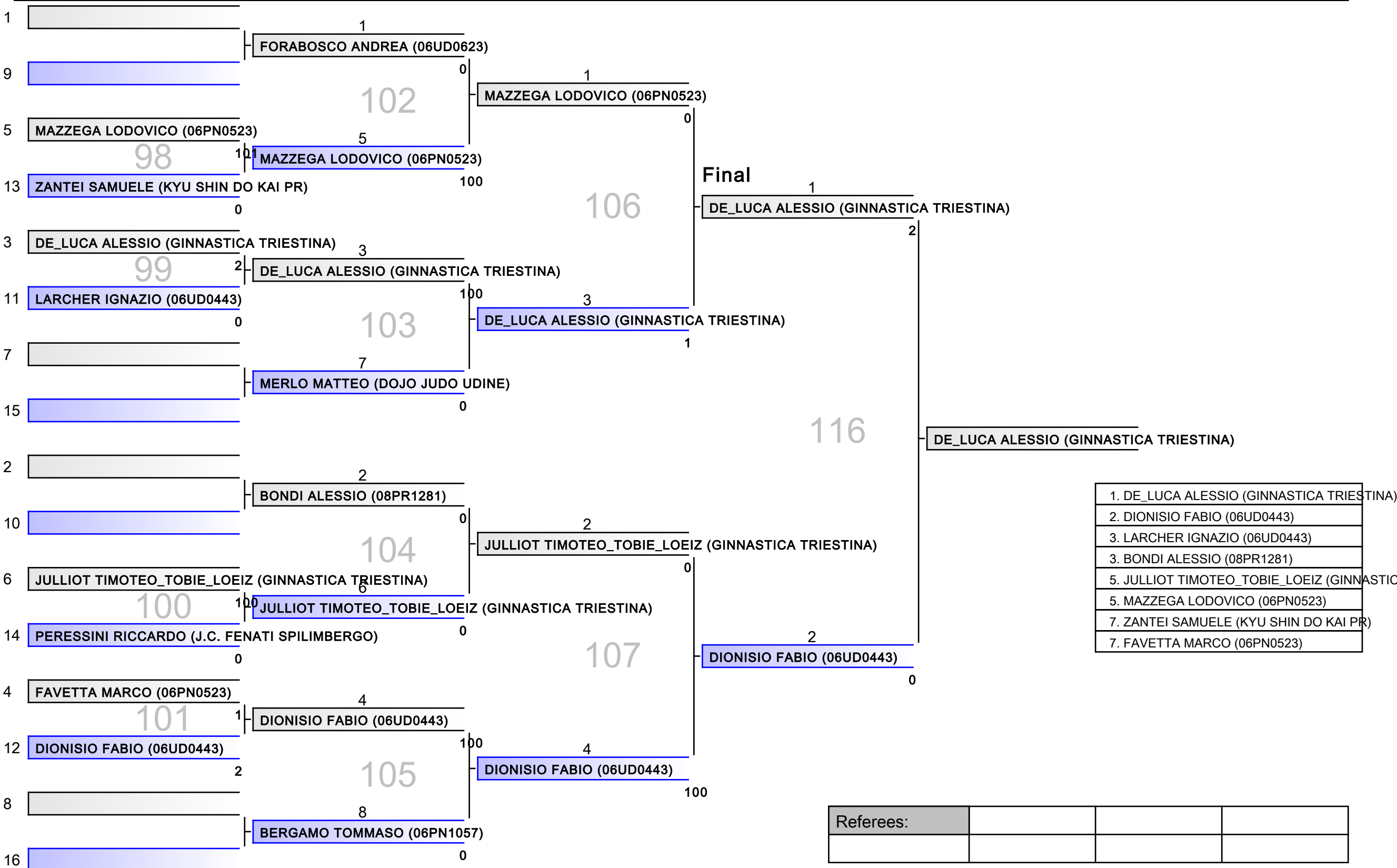

| | | | |
|-----------|--|--|--|
| Referees: | | | |
| | | | |

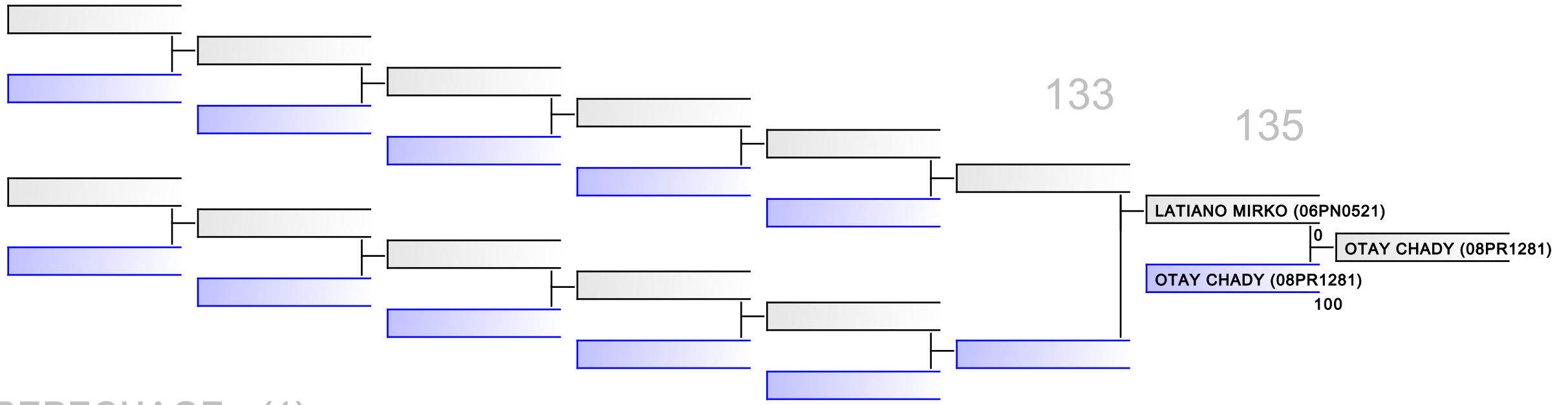

REPECHAGE: (1)

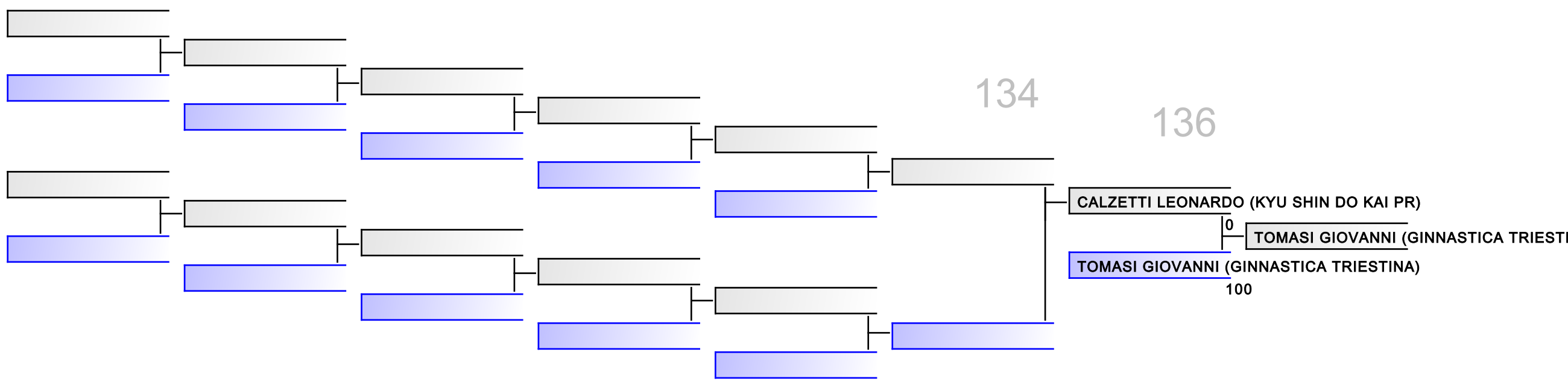

| | | | | | | | |
|-----------|--|--|--|--|--|--|--|
| Referees: | | | | | | | |
|-----------|--|--|--|--|--|--|--|

U15 M -55 KG

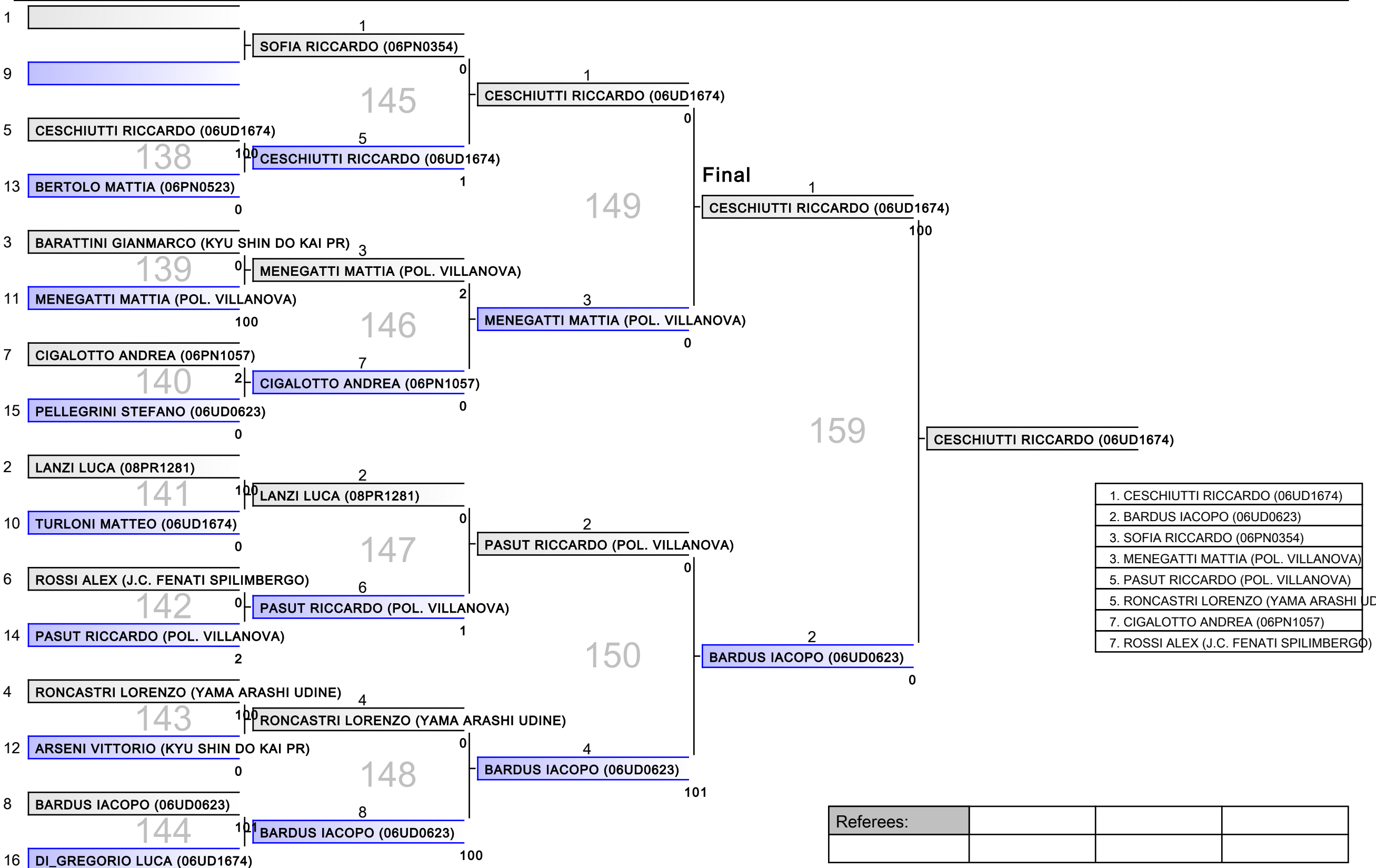

| | | | |
|-----------|--|--|--|
| Referees: | | | |
| | | | |

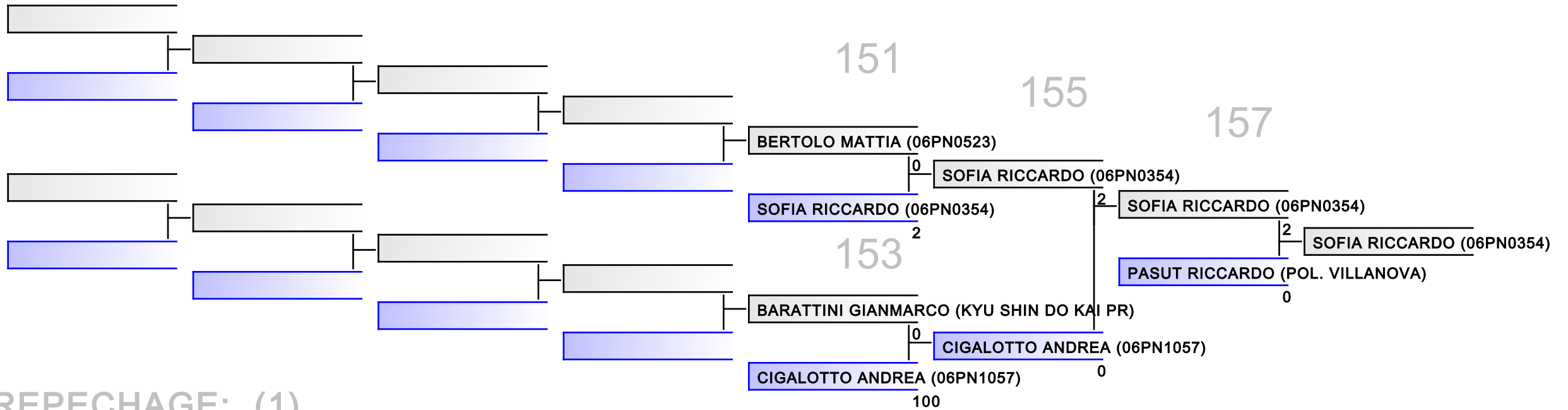

REPECHAGE: (1)

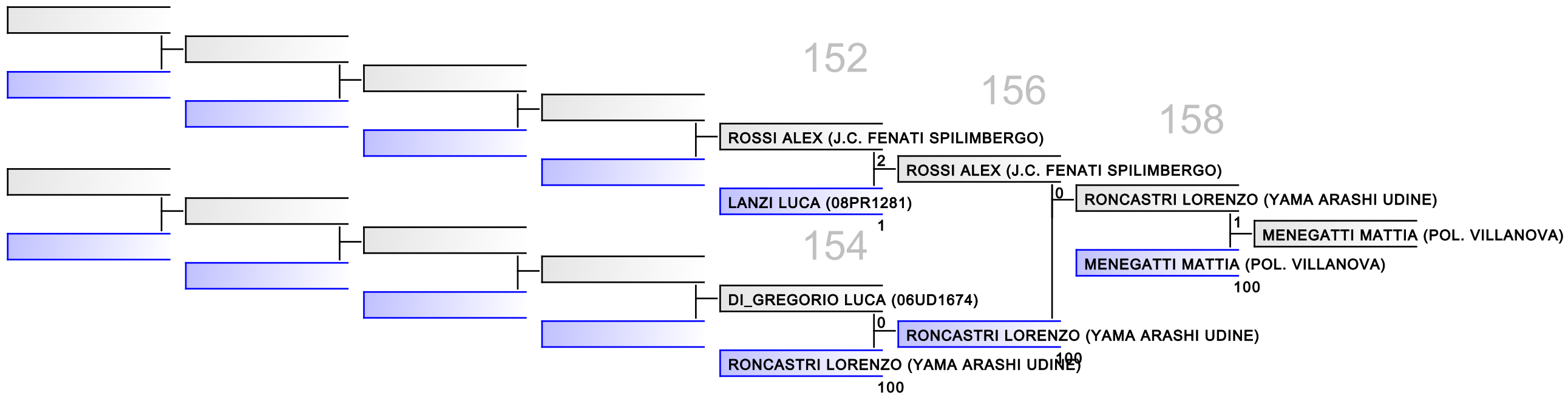

| | | | | | | | |
|-----------|--|--|--|--|--|--|--|
| Referees: | | | | | | | |
|-----------|--|--|--|--|--|--|--|

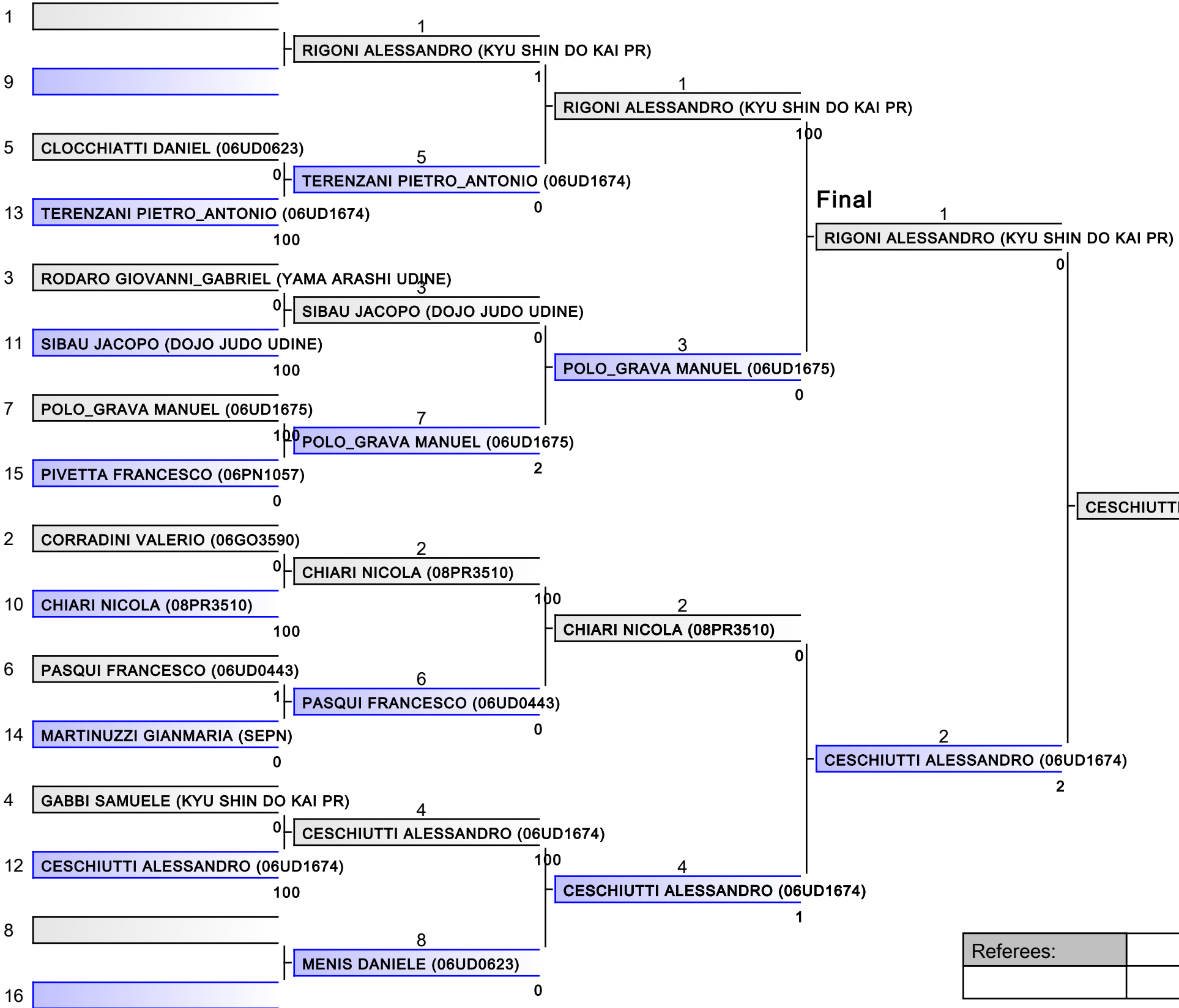

- | |
|---|
| 1. CESCHIUTTI ALESSANDRO (06UD1674) |
| 2. RIGONI ALESSANDRO (KYU SHIN DO KAI PR) |
| 3. CHIARI NICOLA (08PR3510) |
| 3. POLO_GRAVA MANUEL (06UD1675) |
| 5. TEREZANI PIETRO_ANTONIO (06UD1674) |
| 5. GABBI SAMUELE (KYU SHIN DO KAI PR) |
| 7. SIBAU JACOPO (DOJO JUDO UDINE) |
| 7. PASQUI FRANCESCO (06UD0443) |

| | | | |
|-----------|--|--|--|
| Referees: | | | |
| | | | |

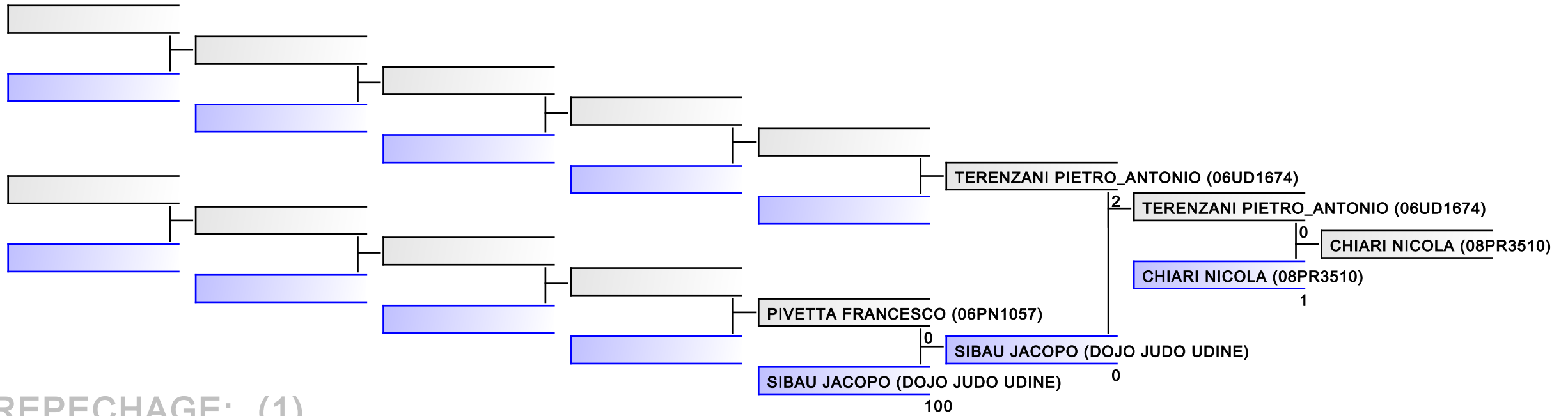

REPECHAGE: (1)

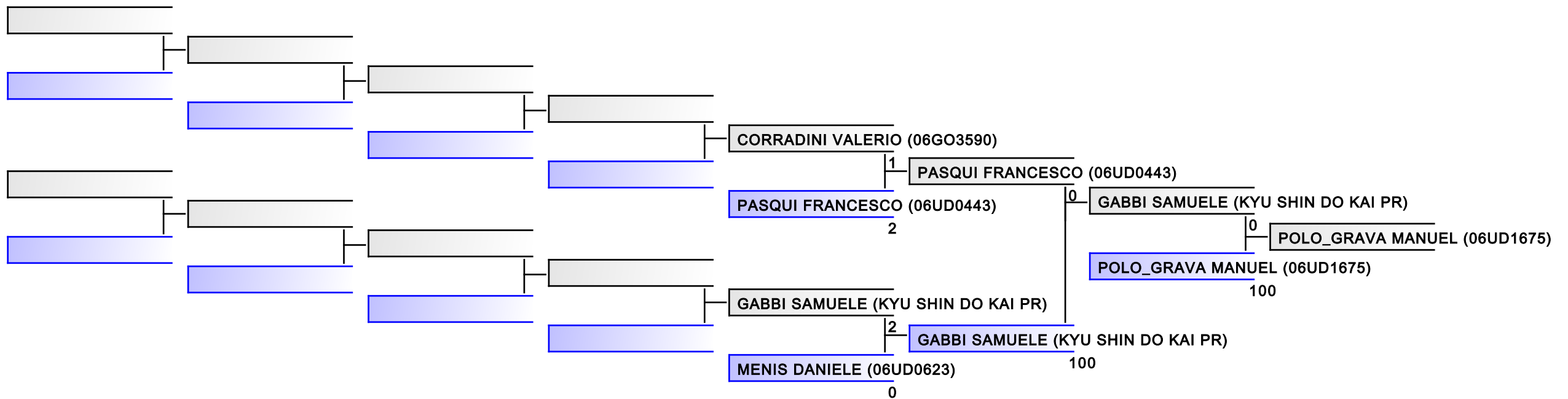

| | | | | | | | |
|-----------|--|--|--|--|--|--|--|
| Referees: | | | | | | | |
|-----------|--|--|--|--|--|--|--|

U15 M -66 KG

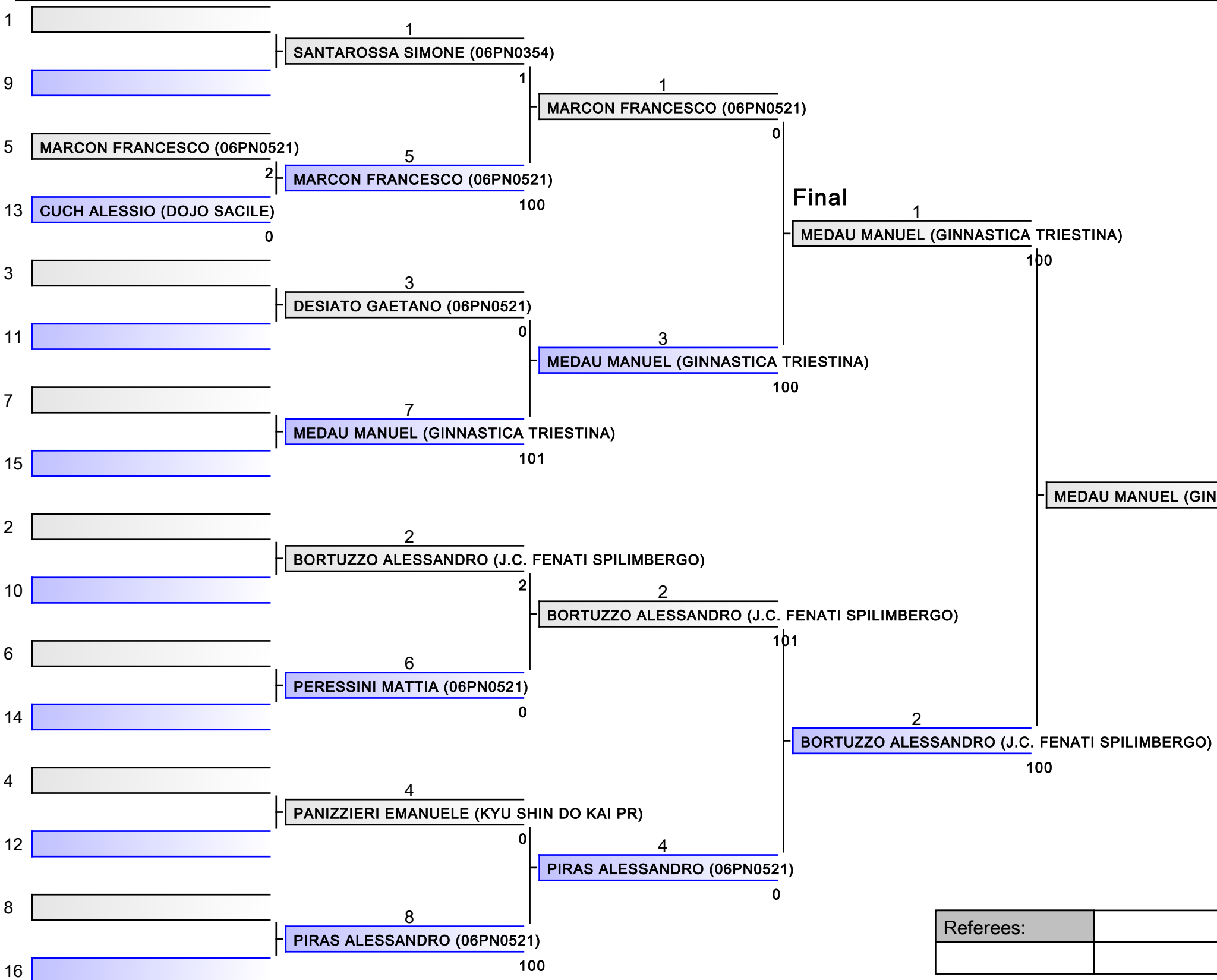

- | |
|--|
| 1. MEDAU MANUEL (GINNASTICA TRIESTINA) |
| 2. BORTUZZO ALESSANDRO (J.C. FENATI SPILIMBERGO) |
| 3. PIRAS ALESSANDRO (06PN0521) |
| 3. PERESSINI MATTIA (06PN0521) |
| 5. DESIATO GAETANO (06PN0521) |
| 5. MARCON FRANCESCO (06PN0521) |
| 7. CUCH ALESSIO (DOJO SACILE) |
| 7. PANIZZIERI EMANUELE (KYU SHIN DO KAI PR) |

| | | | |
|-----------|--|--|--|
| Referees: | | | |
| | | | |

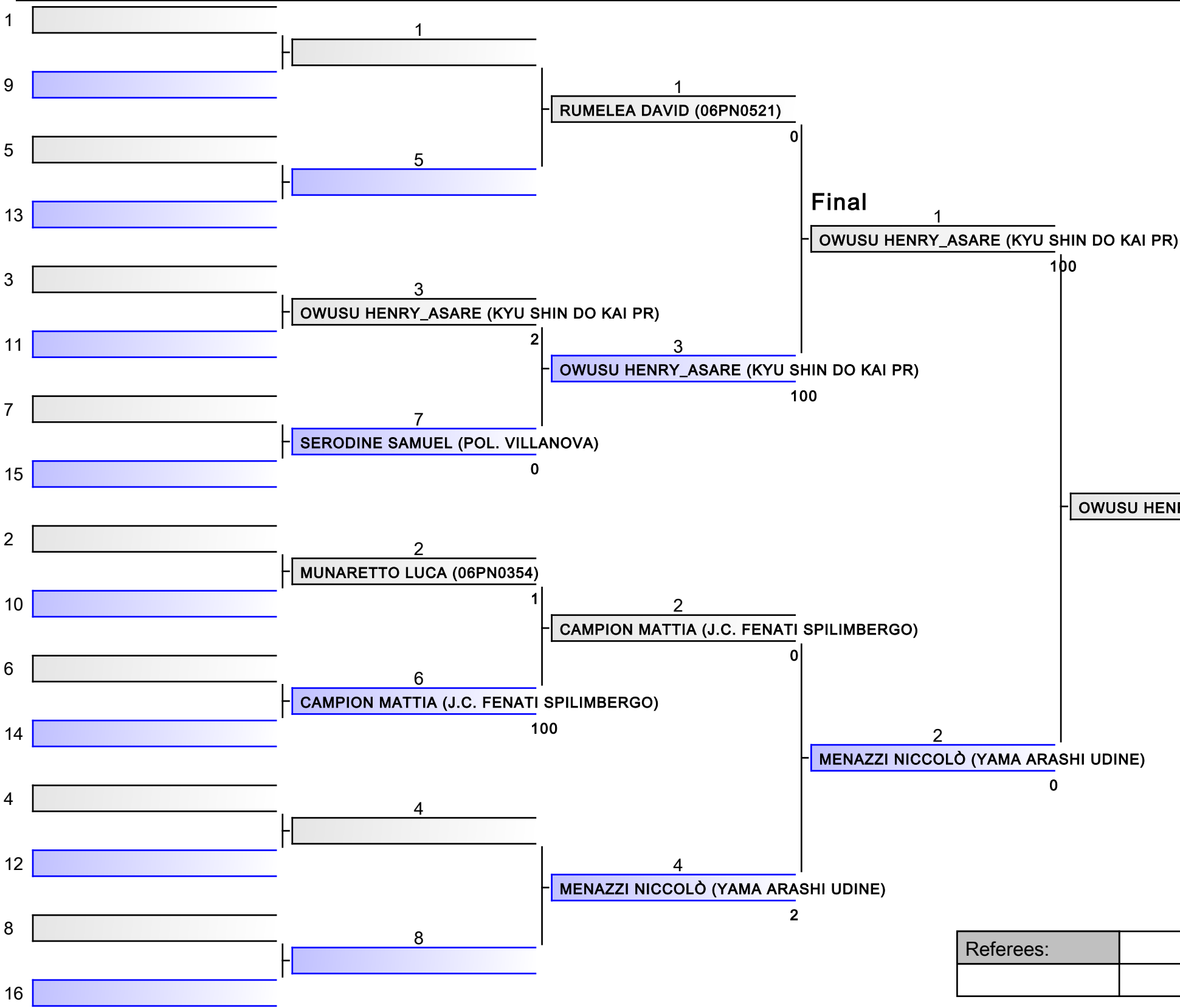

- | |
|---|
| 1. OWUSU HENRY_ASARE (KYU SHIN DO KAI PR) |
| 2. MENAZZI NICCOLÒ (YAMA ARASHI UDINE) |
| 3. SERODINE SAMUEL (POL. VILLANOVA) |
| 3. RUMELEA DAVID (06PN0521) |
| 5. CAMPION MATTIA (J.C. FENATI SPILIMBERGO) |
| 5. MUNARETTO LUCA (06PN0354) |
| |
| |

| | | | |
|-----------|--|--|--|
| Referees: | | | |
| | | | |

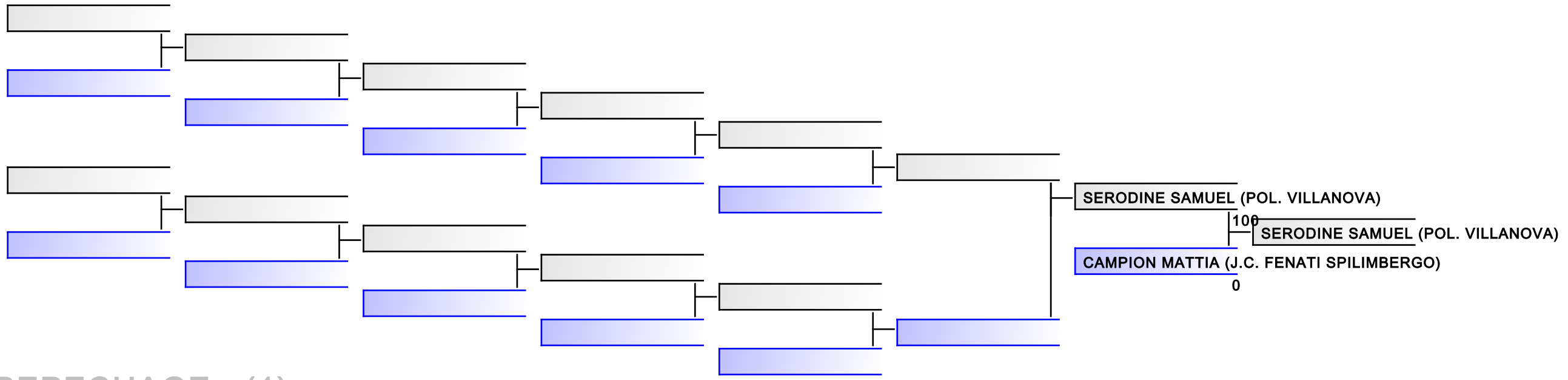

REPECHAGE: (1)

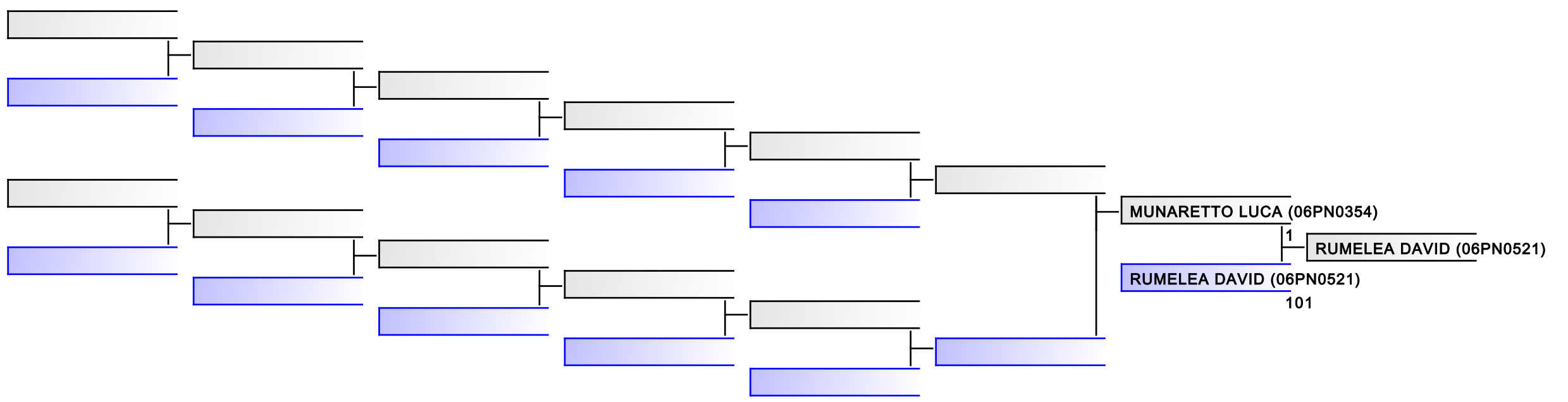

| | | | | | | | |
|-----------|--|--|--|--|--|--|--|
| Referees: | | | | | | | |
|-----------|--|--|--|--|--|--|--|

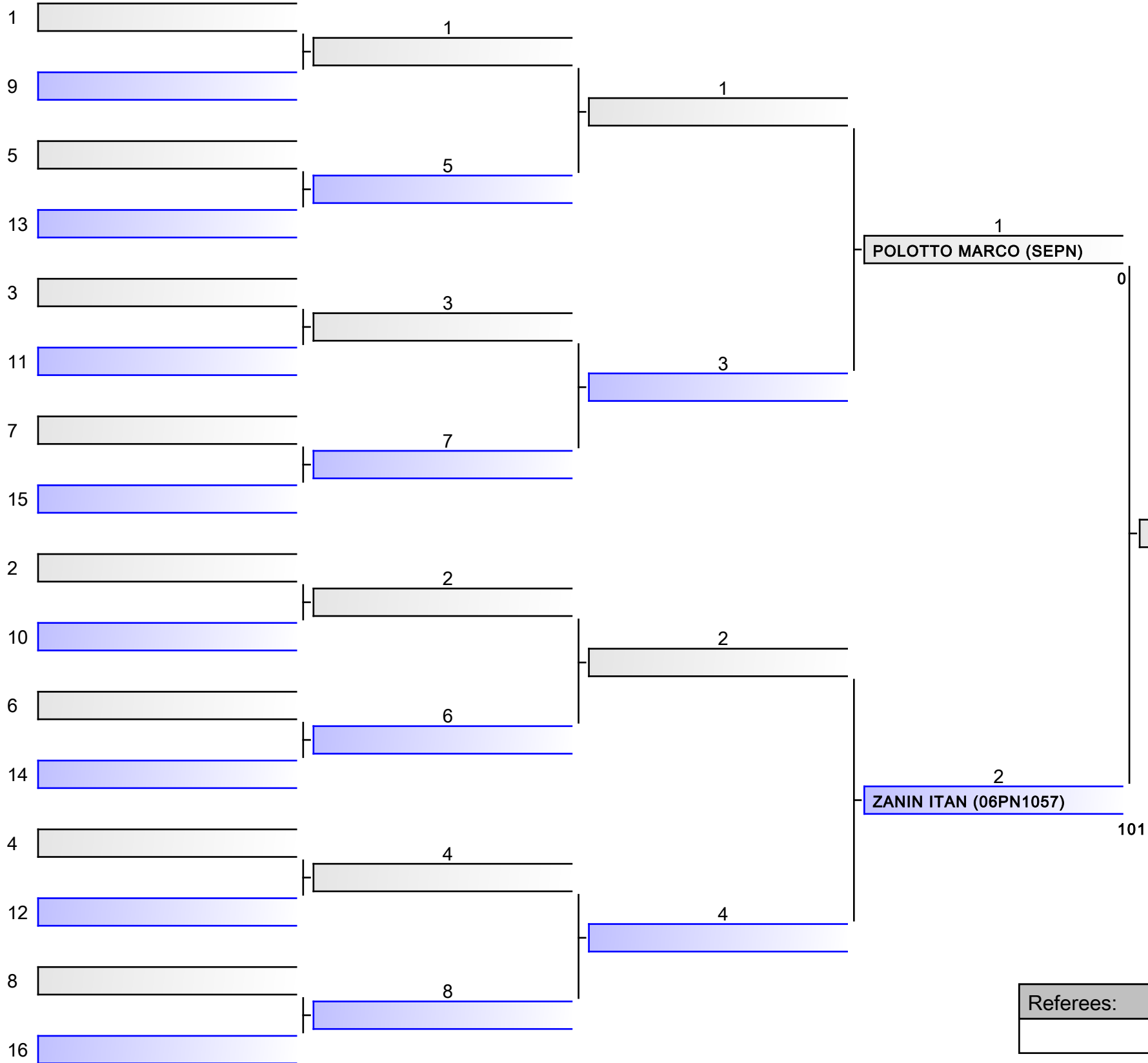

POLOTTO MARCO (SEPN)

| |
|--------------------------|
| 1. POLOTTO MARCO (SEPN) |
| 2. ZANIN ITAN (06PN1057) |
| |
| |
| |
| |
| |

| | | | |
|-----------|--|--|--|
| Referees: | | | |
| | | | |

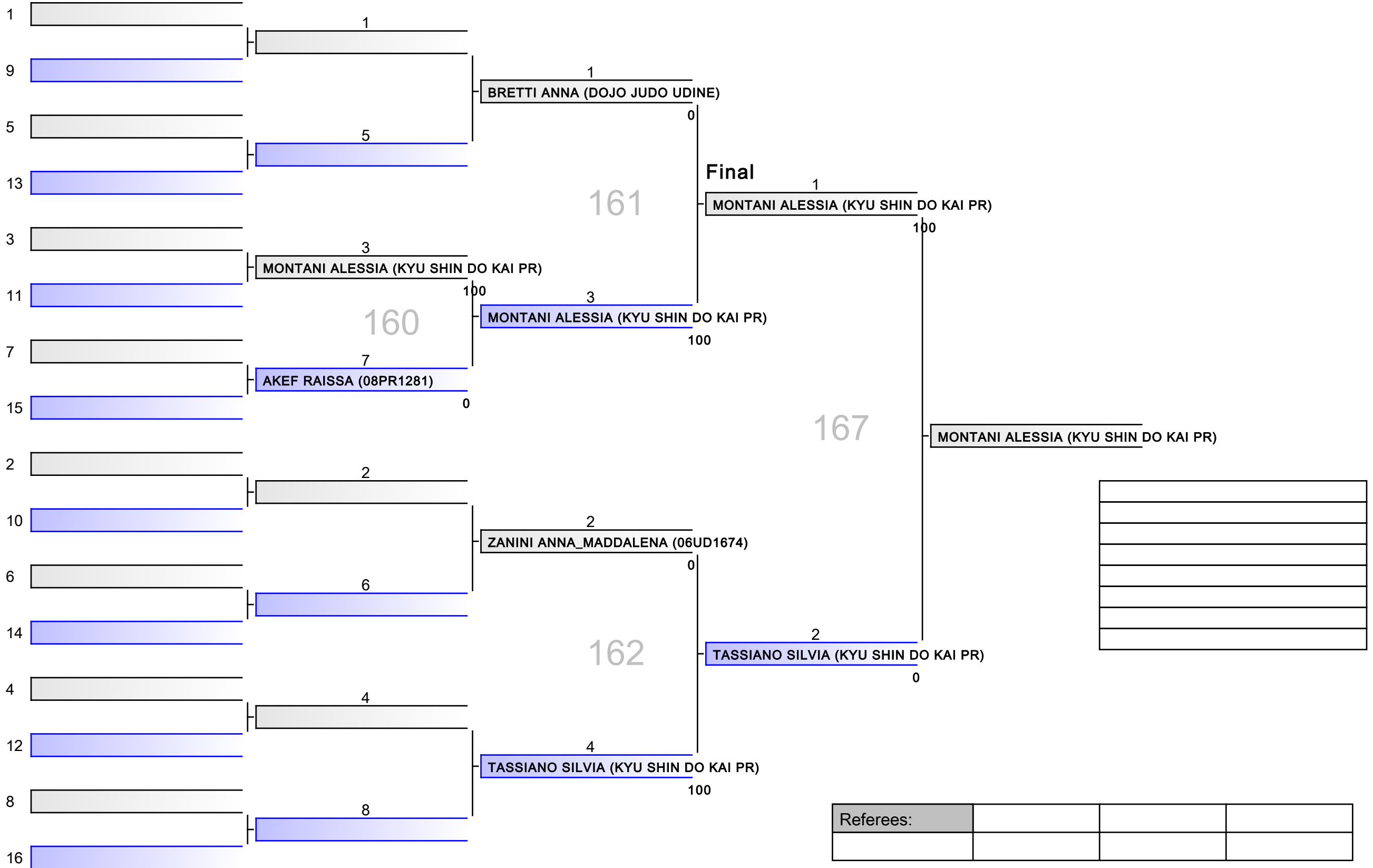

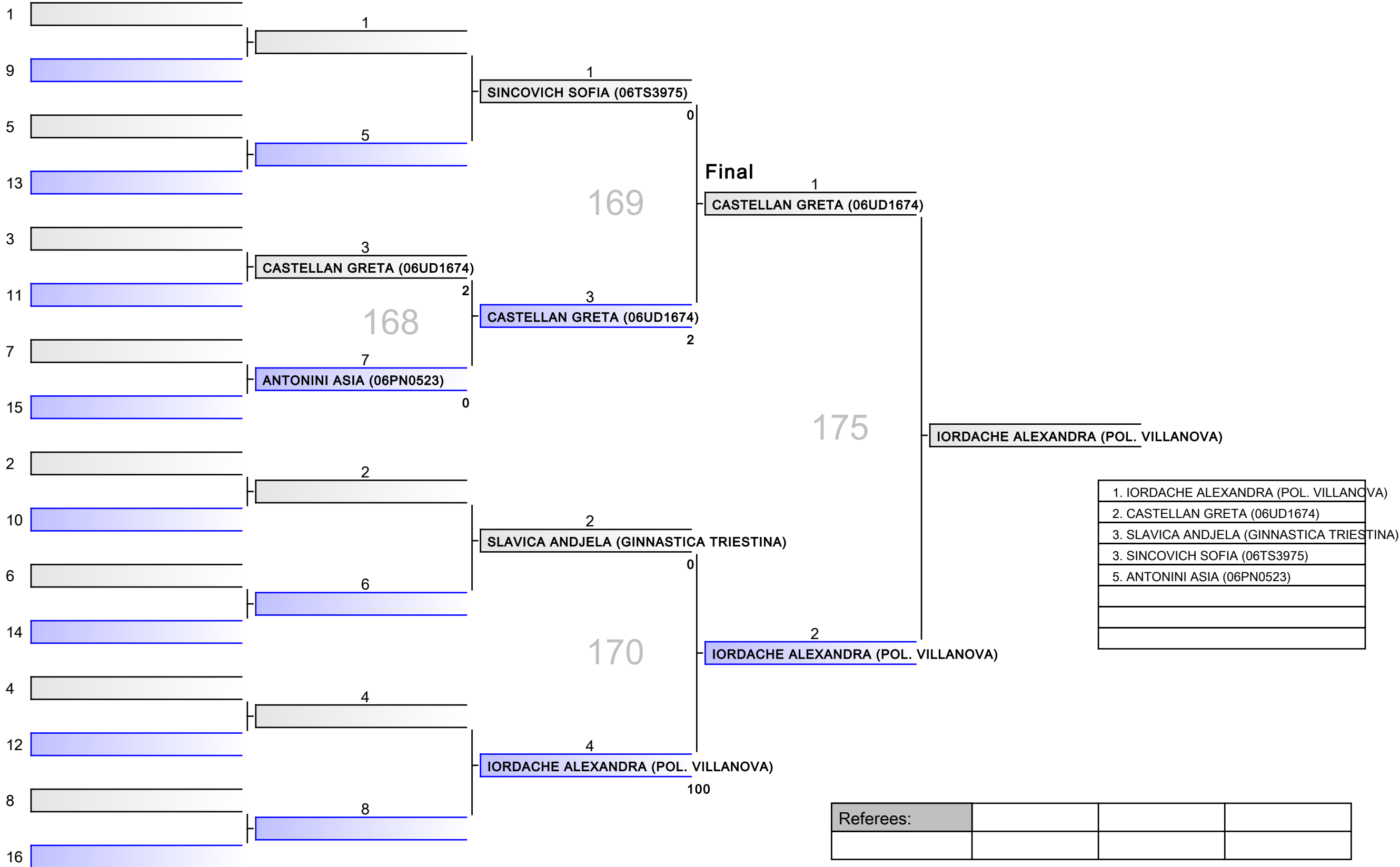

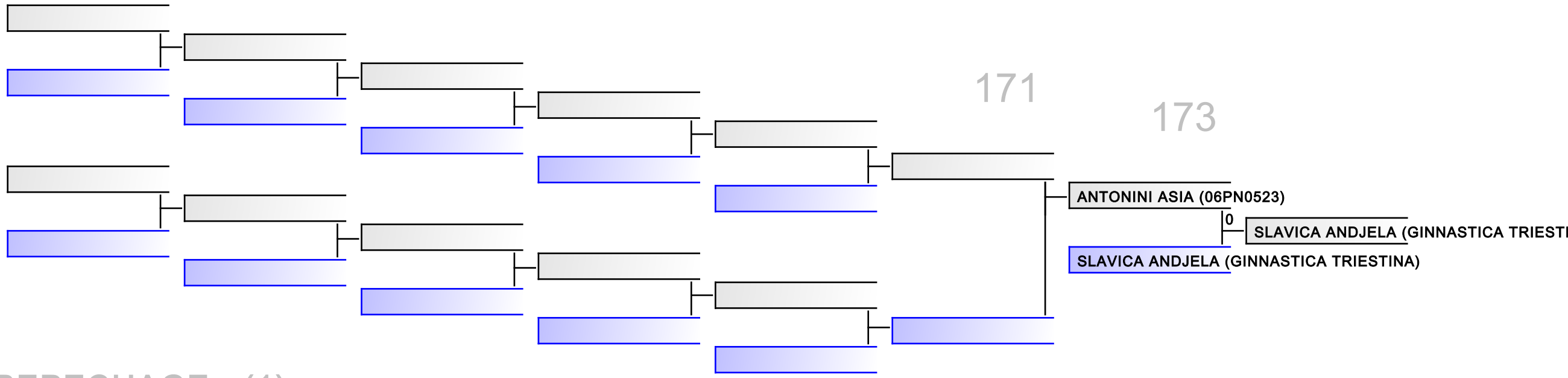

REPECHAGE: (1)

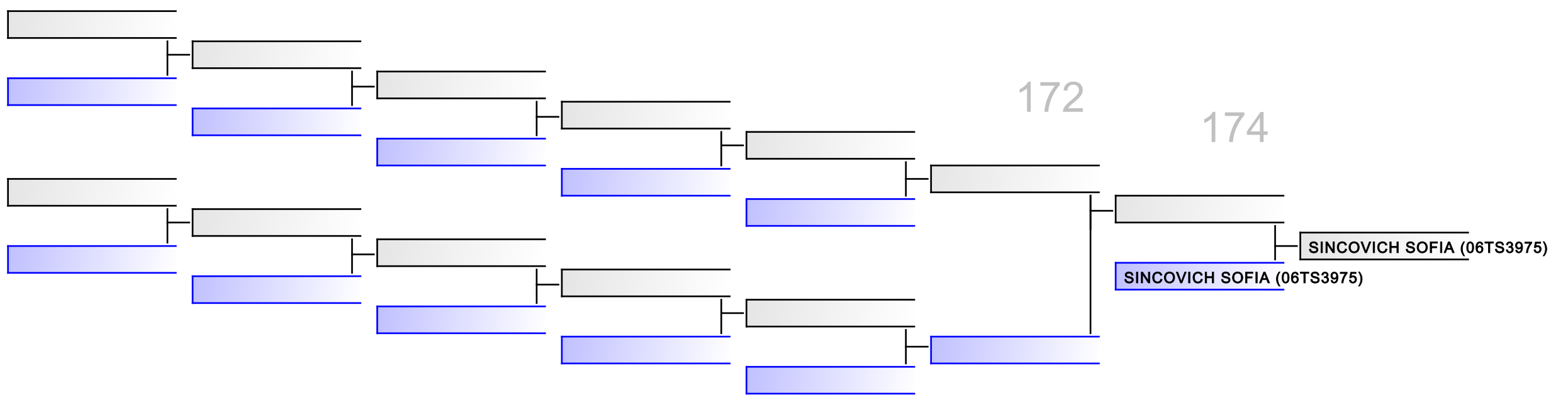

| | | | | | | | |
|-----------|--|--|--|--|--|--|--|
| Referees: | | | | | | | |
|-----------|--|--|--|--|--|--|--|

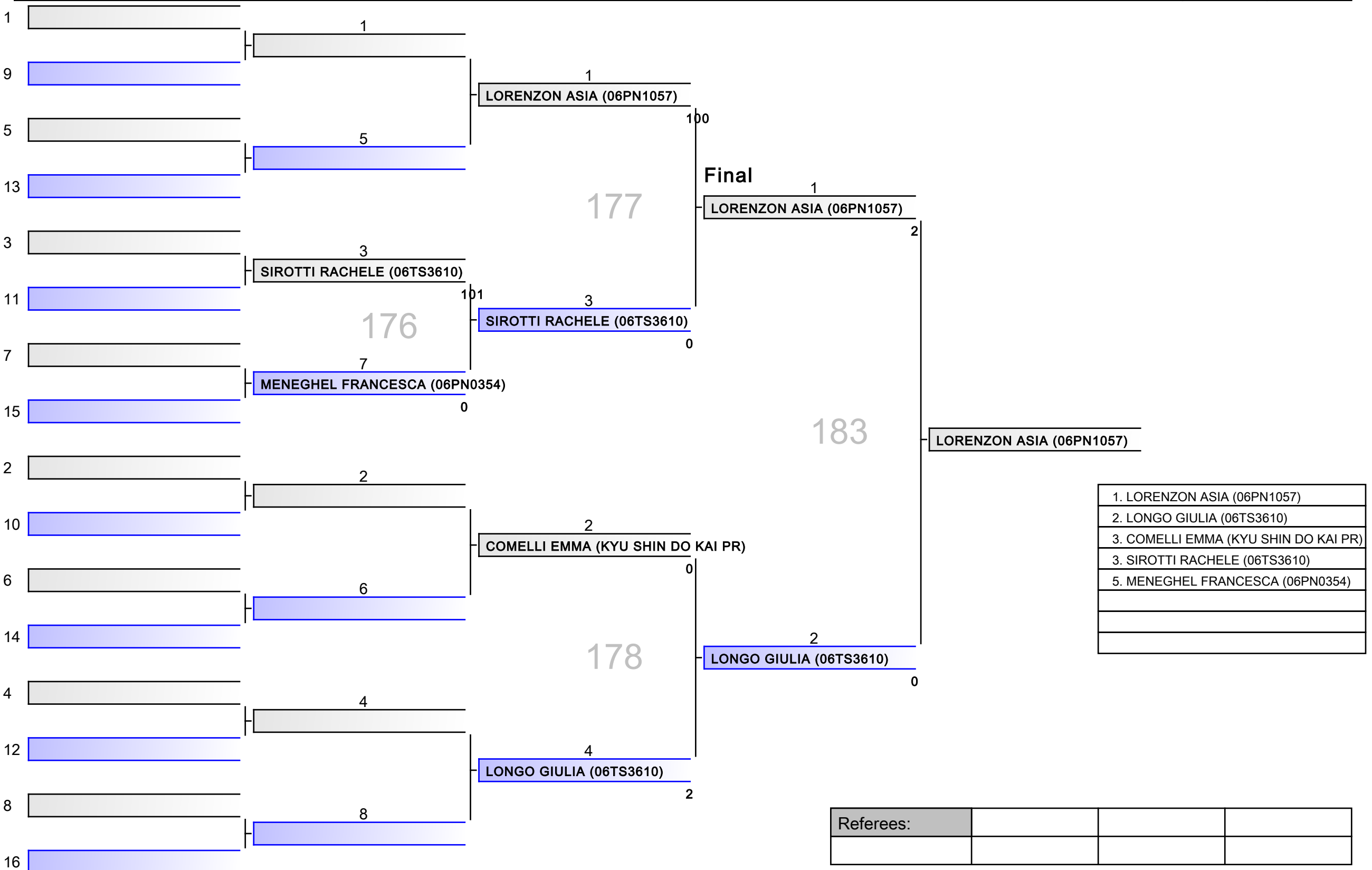

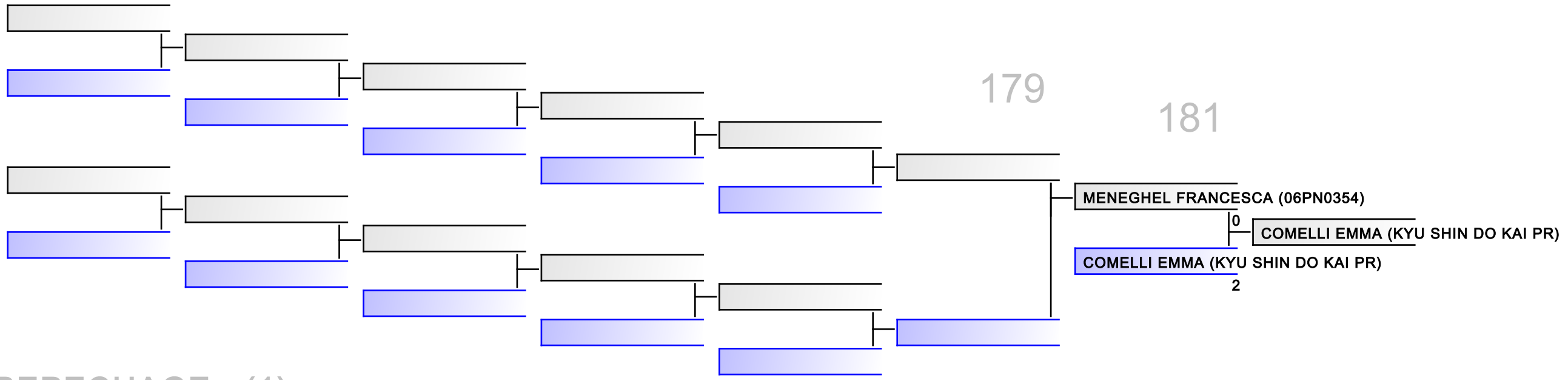

REPECHAGE: (1)

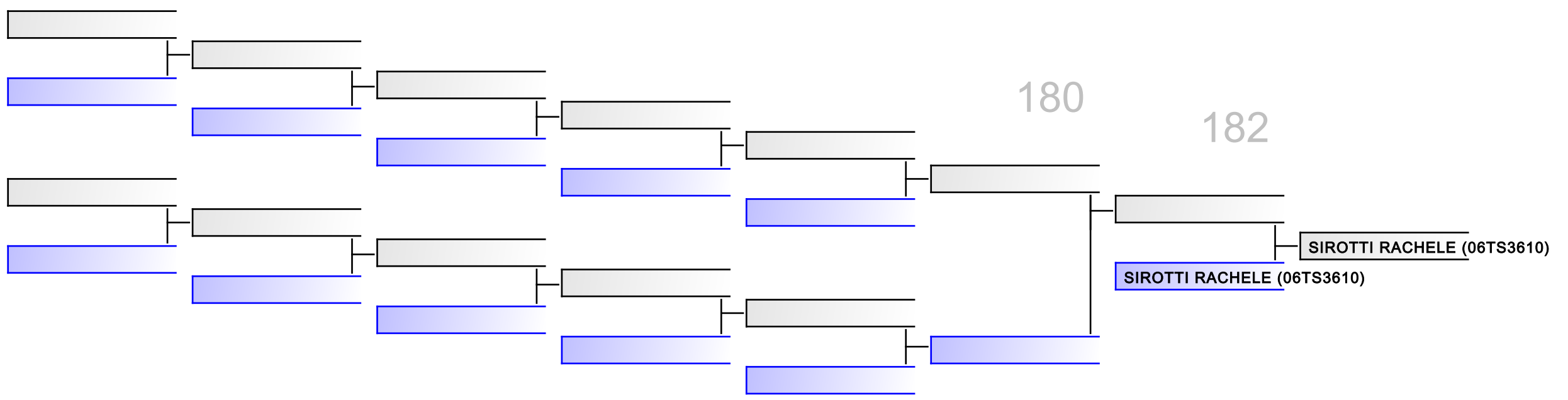

| | | | | | | | |
|-----------|--|--|--|--|--|--|--|
| Referees: | | | | | | | |
|-----------|--|--|--|--|--|--|--|

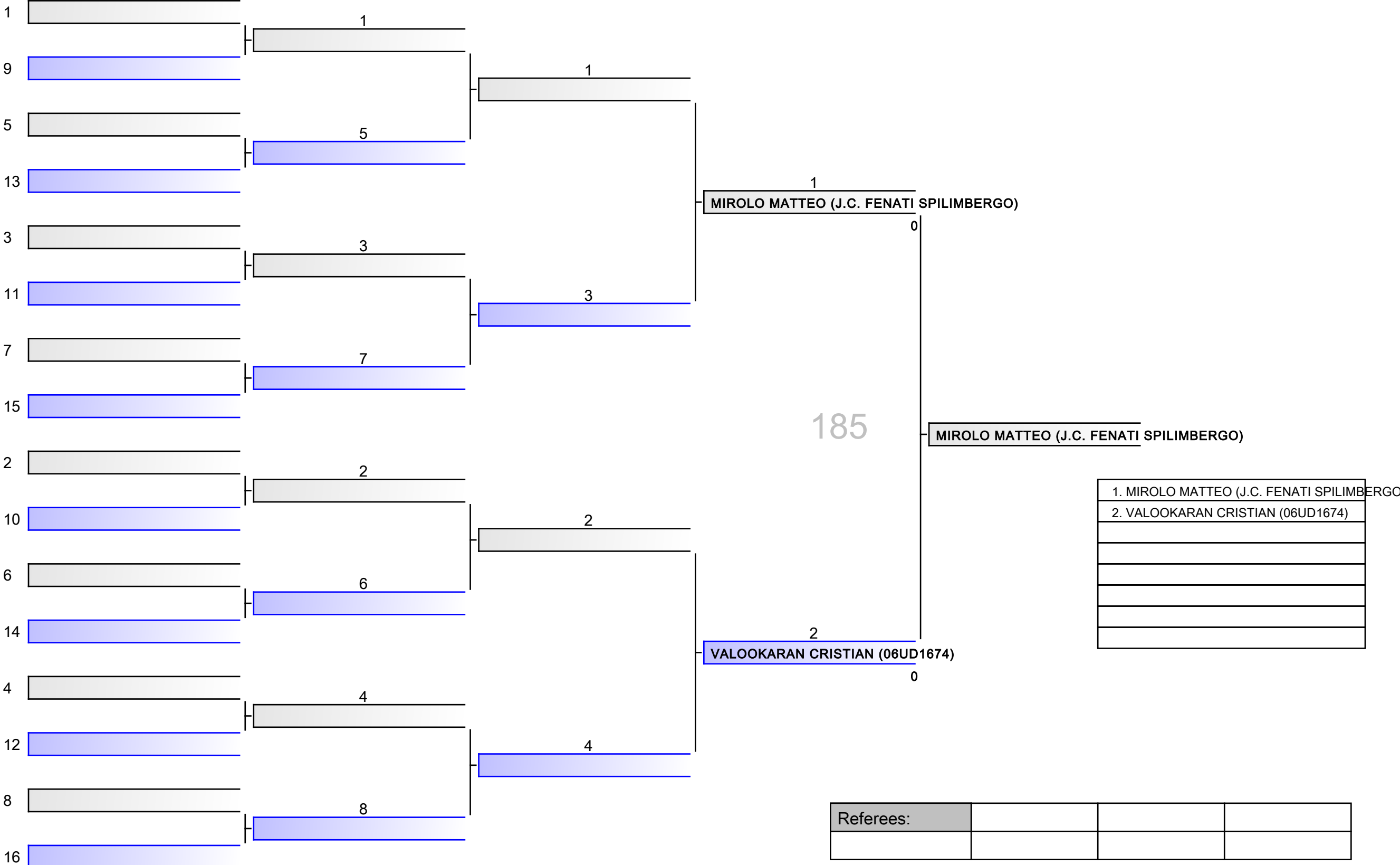

| |
|--|
| 1. MIROLO MATTEO (J.C. FENATI SPILIMBERGO) |
| 2. VALOOKARAN CRISTIAN (06UD1674) |
| |
| |
| |
| |
| |

| | | | |
|-----------|--|--|--|
| Referees: | | | |
| | | | |

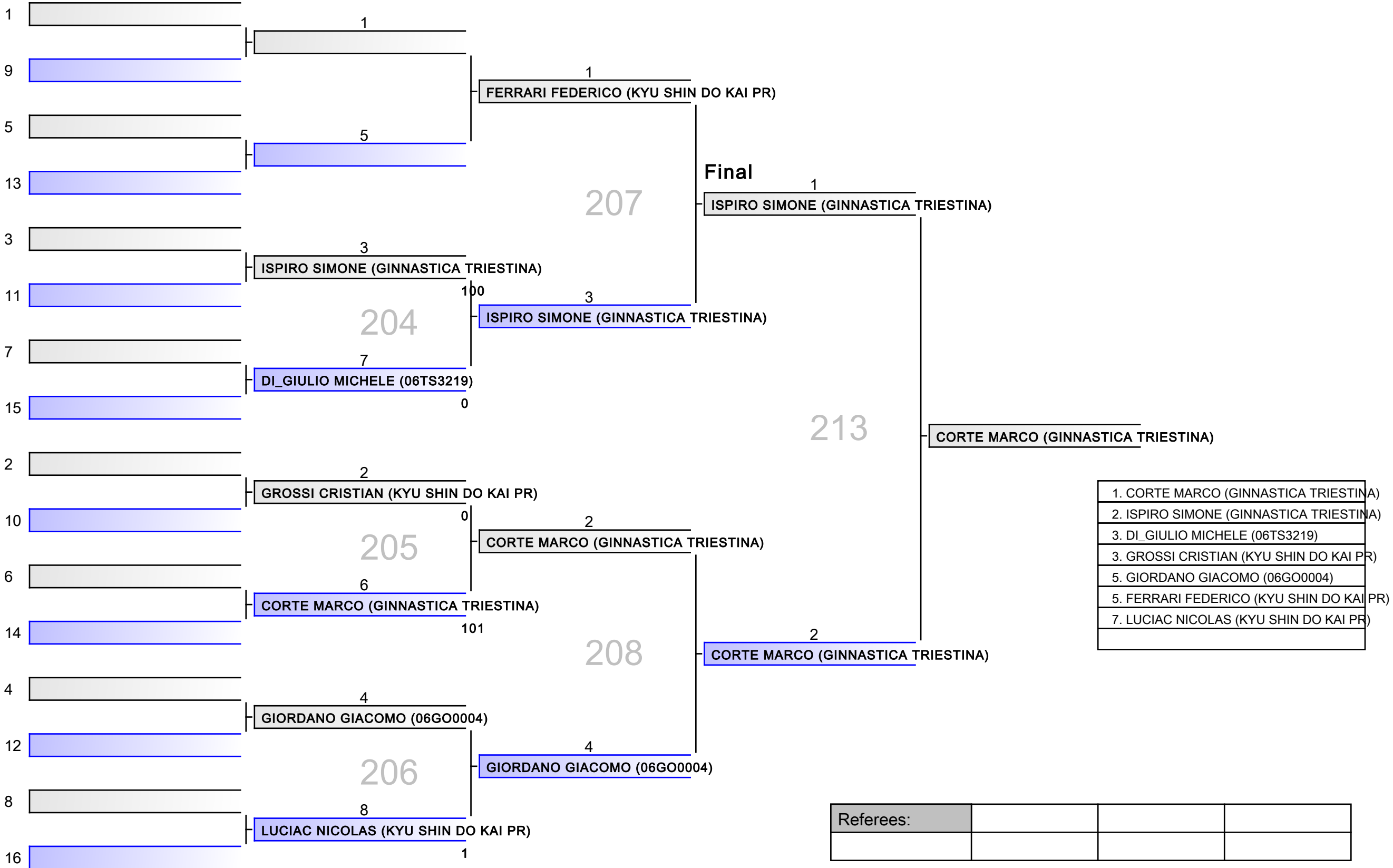

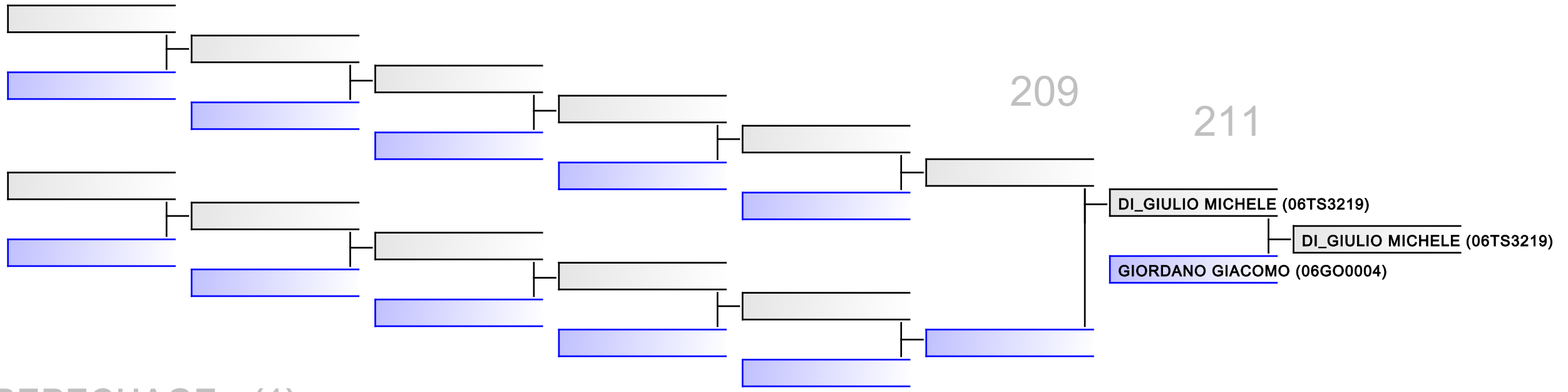

REPECHAGE: (1)

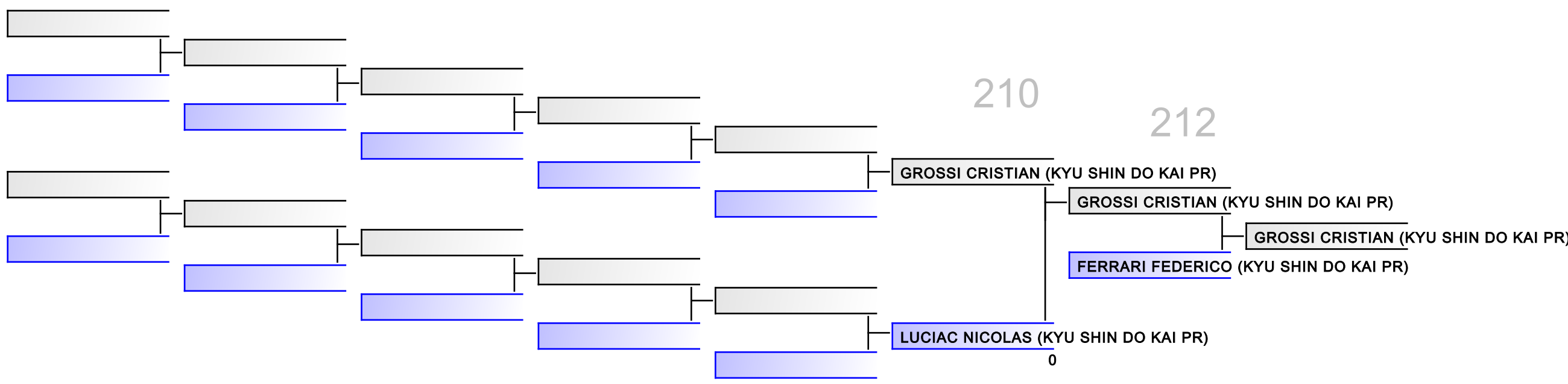

| | | | | | | | |
|-----------|--|--|--|--|--|--|--|
| Referees: | | | | | | | |
|-----------|--|--|--|--|--|--|--|

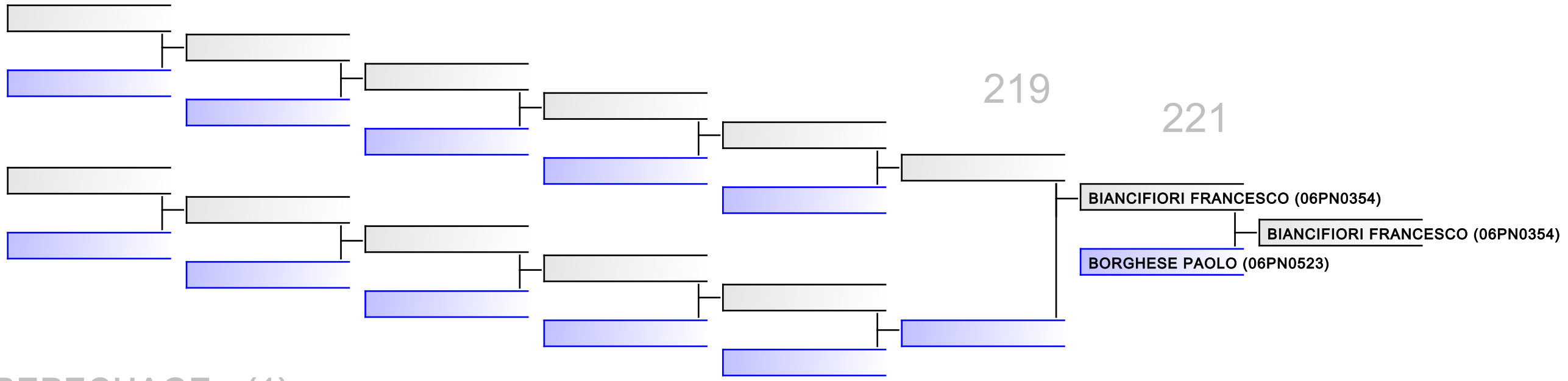

REPECHAGE: (1)

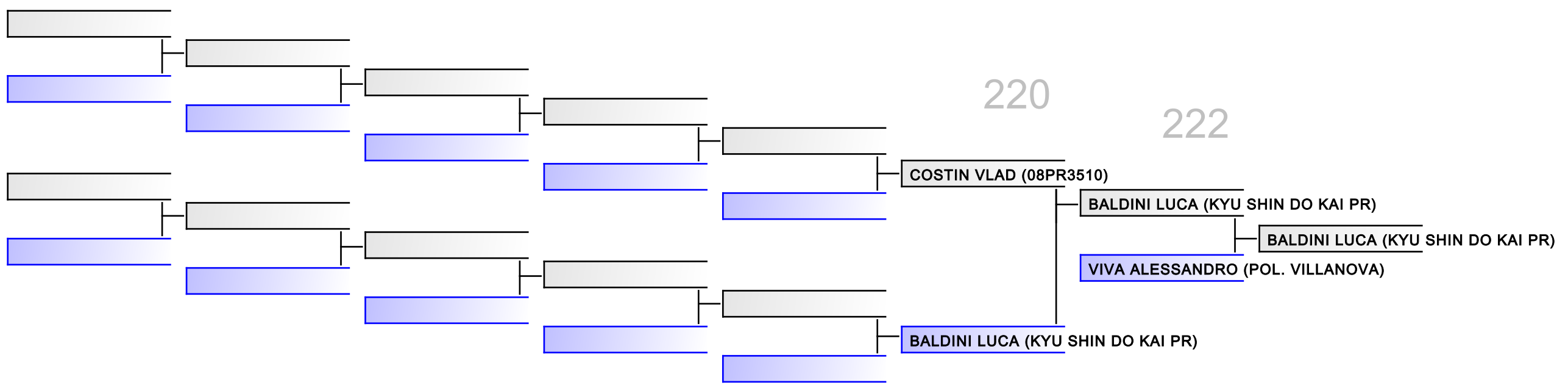

| | | | | | | | |
|-----------|--|--|--|--|--|--|--|
| Referees: | | | | | | | |
|-----------|--|--|--|--|--|--|--|

U18 M -66 KG

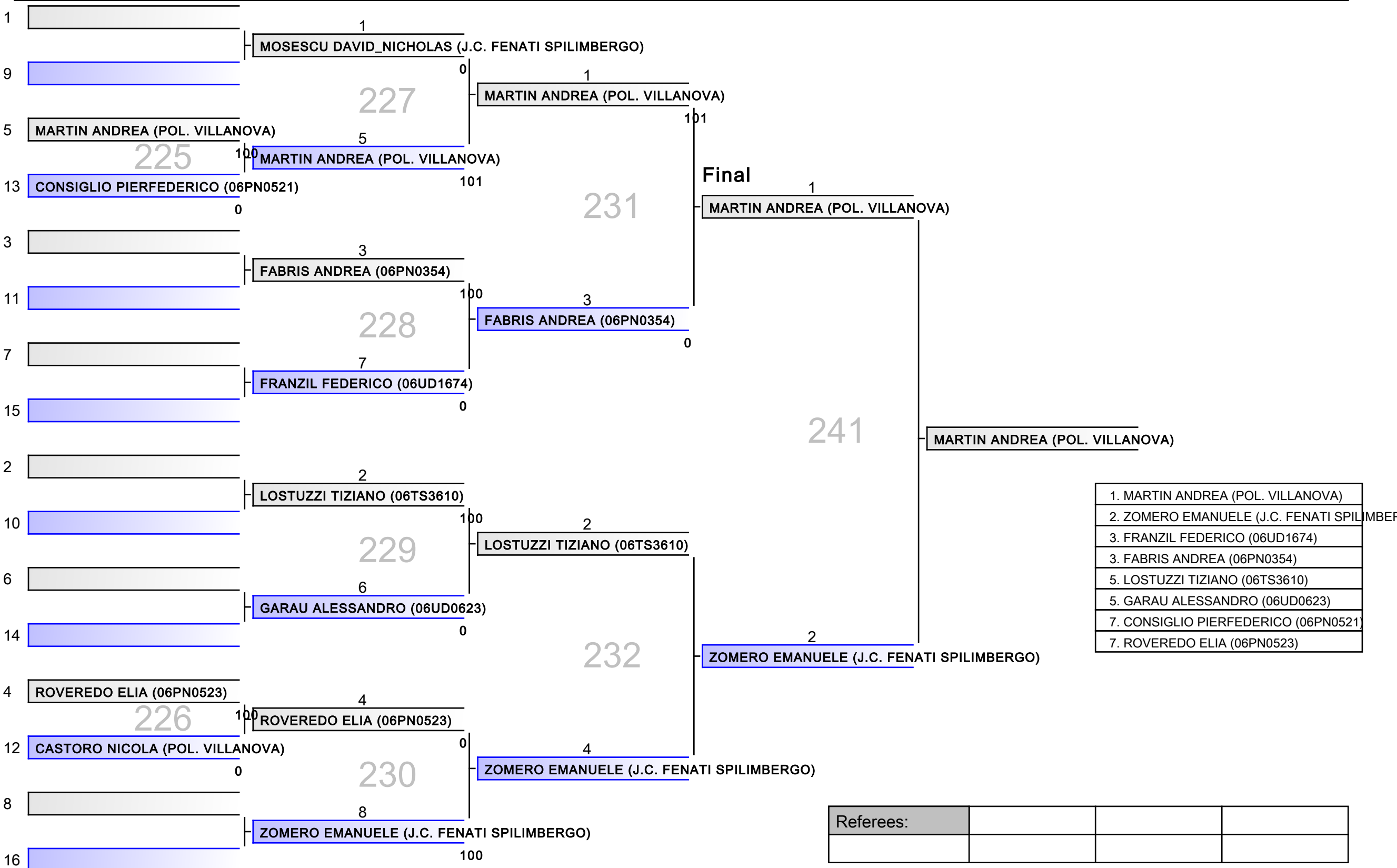

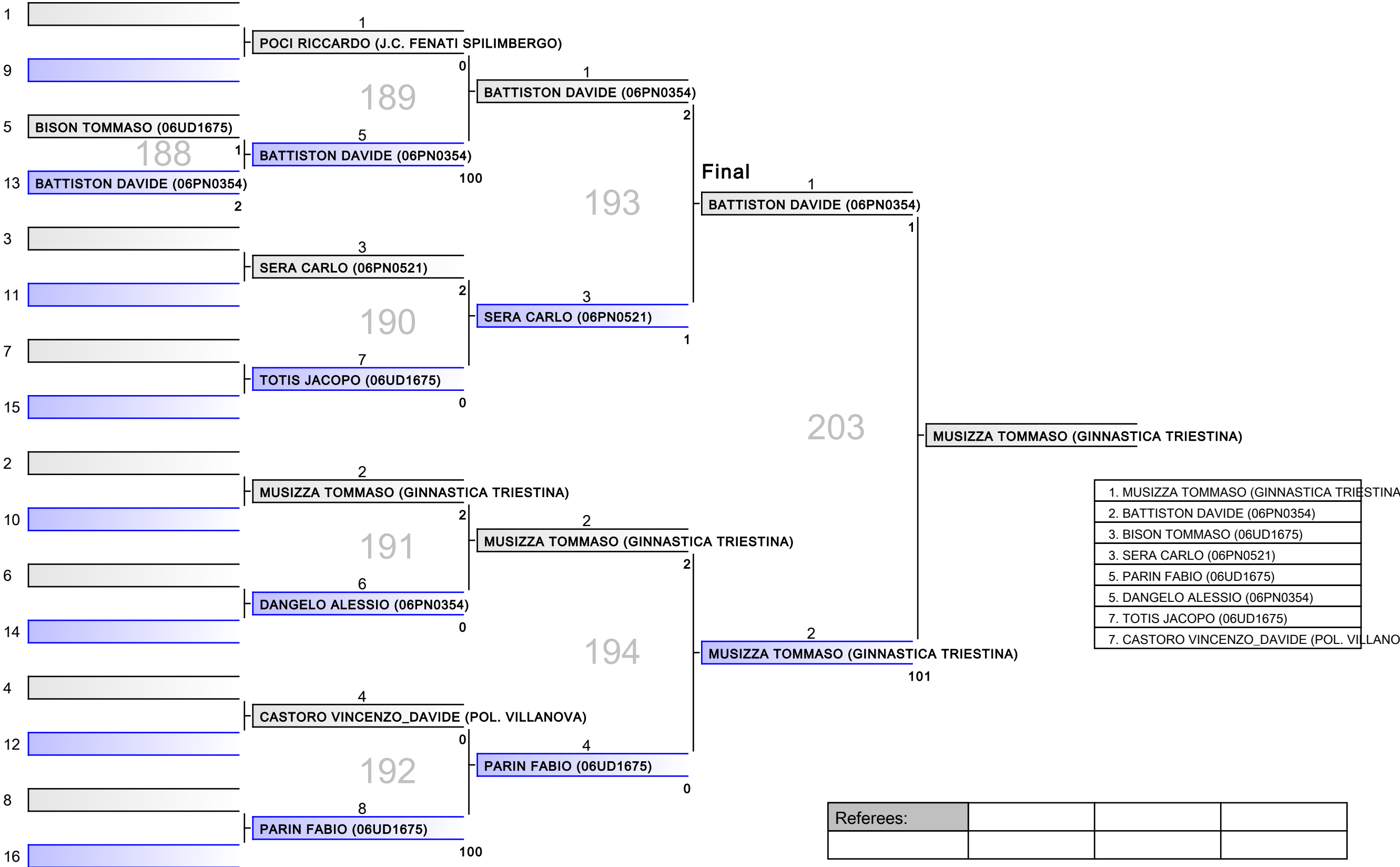

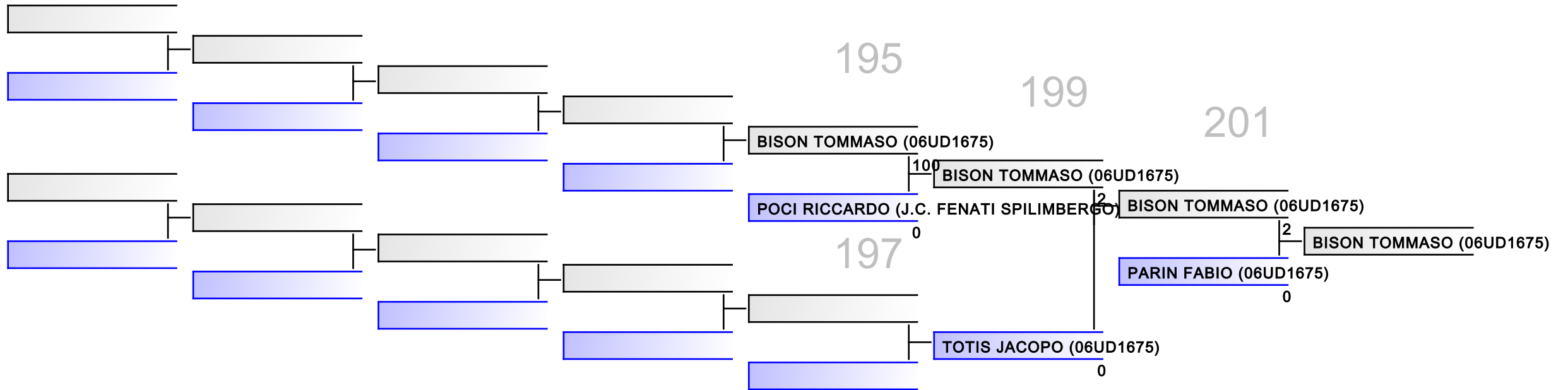

REPECHAGE: (1)

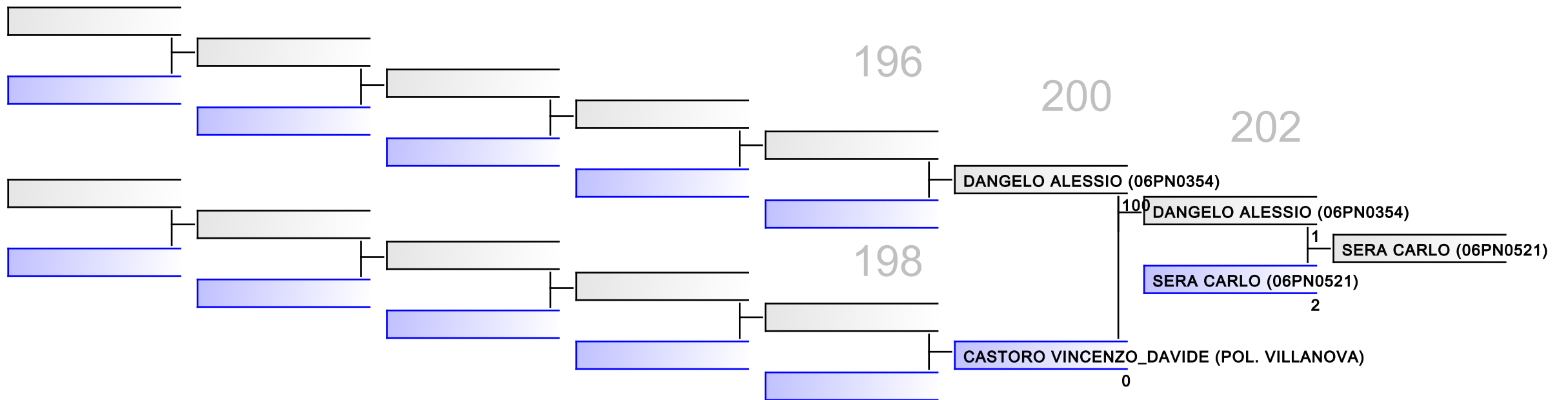

| | | | | | | | |
|-----------|--|--|--|--|--|--|--|
| Referees: | | | | | | | |
|-----------|--|--|--|--|--|--|--|

U18 M -81 KG - Round Robin (each against each)

| | | | |
|----|------------------------------|-----|-----------------------------|
| 1 | MOURLOT LEONARDO (06PN0354) | 242 | MOURLOT LEONARDO (06PN0354) |
| 2 | MARZARO GABRIELE (06UD0623) | | |
| 3 | FULIGNI AMOS (06UD1675) | 243 | FULIGNI AMOS (06UD1675) |
| 4 | DE_MARIN RICCARDO (06PN1057) | 0 | |
| 5 | FULIGNI AMOS (06UD1675) | 244 | MOURLOT LEONARDO (06PN0354) |
| 6 | MOURLOT LEONARDO (06PN0354) | 100 | |
| 7 | DE_MARIN RICCARDO (06PN1057) | 245 | MARZARO GABRIELE (06UD0623) |
| 8 | MARZARO GABRIELE (06UD0623) | 101 | |
| 9 | MOURLOT LEONARDO (06PN0354) | 246 | MOURLOT LEONARDO (06PN0354) |
| 10 | DE_MARIN RICCARDO (06PN1057) | 0 | |
| 11 | MARZARO GABRIELE (06UD0623) | 247 | FULIGNI AMOS (06UD1675) |
| 12 | FULIGNI AMOS (06UD1675) | 1 | |
| 13 | | | |
| 14 | | | |
| 15 | | | |
| 16 | | | |

| |
|---------------------------------|
| 1. MOURLOT LEONARDO (06PN0354) |
| 2. FULIGNI AMOS (06UD1675) |
| 3. MARZARO GABRIELE (06UD0623) |
| 4. DE_MARIN RICCARDO (06PN1057) |
| |
| |
| |











| | | | |
|-----------|--|--|--|
| Referees: | | | |
| | | | |



















FEDERAZIONE ITALIANA JUDO LOTTA KARATE ARTI MARZIALI

Classifica Società Sportive

3° TROFEO INTERNAZIONALE DI JUDO MONTEREALE VALCELLINA - 2018-03-18

| Rank | Club | Athlete | 1. Place | 2. Place | 3. Place | 5. Place | 7. Place | 11. Place | Total |
|------|---|---------|----------|----------|----------|----------|----------|-----------|-------|
| 1 |  SOCIETA GINNASTICA TRIESTINA ASSOCIAZIONE SPORTIVA DILETTANTISTICA, 06TS0002, ITA | 18 | 10 | 3 | 3 | 1 | 1 | 0 | 130 |
| 2 |  A.S.DILETTANTISTICA SPORT TEAM JUDO UDINE, 06UD1674, ITA | 18 | 4 | 4 | 5 | 2 | 0 | 0 | 84 |
| 3 |  KYU SHIN DO KAI PARMA ASSOCIAZIONE SPORTIVA DILETTANTISTICA, 08PR1231, ITA | 28 | 2 | 4 | 7 | 7 | 3 | 0 | 72 |
| 4 |  POLISPORTIVA VILLANOVA ASSOCIAZIONE SPORTIVA DILETTANTISTICA JUDO LIB., 06PN0690, ITA | 11 | 3 | 2 | 2 | 2 | 1 | 0 | 50 |
| 5 |  ASSOCIAZIONE SPORTIVA DILETTANTISTICA POLISPORTIVA DLF YAMA ARASHI JUDO UDINE, 06UD0736, ITA | 15 | 0 | 5 | 4 | 3 | 1 | 0 | 46 |
| 6 |  POLISPORTIVA MONTEREALE SOCIETA DILETTANTISTICA, 06PN0523, ITA | 13 | 2 | 3 | 1 | 4 | 2 | 0 | 42 |
| 7 |  ASSOCIAZIONE SPORTIVA DILETTANTISTICA POL.JUDO CLUB SHIMAI DOJO, 06UD1675, ITA | 8 | 2 | 2 | 2 | 1 | 1 | 0 | 40 |
| 8 |  ASSOCIAZIONE SPORTIVA DILETTANTISTICA JUDO AZZANESE, 06PN0354, ITA | 13 | 1 | 2 | 4 | 3 | 1 | 0 | 38 |
| 9 |  ASSOCIAZIONE SPORTIVA DILETTANTISTICA JUDO CLUB GIANFRANCO FENATI, 06PN0103, ITA | 11 | 1 | 2 | 1 | 2 | 2 | 0 | 26 |
| |  ASSOCIAZIONE SPORTIVA DILETTANTISTICA POLISPORTIVA TAMAI SEZIONE JUDO LIBERTAS, 06PN1057, ITA | 9 | 1 | 2 | 1 | 0 | 1 | 0 | 26 |

Classifica Società Sportive / 3° TROFEO INTERNAZIONALE DI JUDO MONTEREALE VALCELLINA - 2018-03-18

| | | | | | | | | | |
|----|--|----|---|---|---|---|---|---|----|
| |  ASSOCIAZIONE SPORTIVA DILETTANTISTICA JUDO CLUB SAN VITO, 06PN0521, ITA | 10 | 1 | 0 | 4 | 4 | 1 | 0 | 26 |
| 12 |  ASSOCIAZIONE SPORTIVA DILETTANTISTICA DOJO SACILE, 06PN1518, ITA | 6 | 2 | 0 | 1 | 1 | 2 | 0 | 24 |
| |  A&R PALESTRE S.S.DILETTANTISTICA A R.L., 06TS3610, ITA | 6 | 1 | 1 | 2 | 2 | 0 | 0 | 24 |
| 14 |  SEKAI BUDO PORDENONE, , ITA | 3 | 2 | 0 | 0 | 0 | 0 | 0 | 20 |
| |  ASSOCIAZIONE SPORTIVA DILETTANTISTICA JUDO CLUB TOLMEZZO, 06UD0443, ITA | 4 | 1 | 1 | 1 | 0 | 1 | 0 | 20 |
| |  ASSOCIAZIONE SPORTIVA DILETTANTISTICA JUDO KUROKI, 06UD0623, ITA | 14 | 0 | 2 | 2 | 2 | 2 | 0 | 20 |
| |  POL. AGOSTINO LANZI ASSOCIAZIONE SPORTIVA DILETTANTISTICA, 08PR1281, ITA | 6 | 0 | 0 | 5 | 0 | 0 | 0 | 20 |
| 18 |  A.S.DILETTANTISTICA TEAM JUDO TRIESTE, 06TS3219, ITA | 4 | 1 | 0 | 2 | 1 | 0 | 0 | 18 |
| 19 |  ISAO OKANO, , ITA | 0 | 1 | 0 | 0 | 0 | 0 | 0 | 10 |
| |  ASSOCIAZIONE SPORTIVA DILETTANTISTICA JUDO CLUB KEN OTANI, 06TS0400, ITA | 1 | 1 | 0 | 0 | 0 | 0 | 0 | 10 |
| 21 |  S.S.DILETTANTISTICA A R.L. UNINOMINALE D.L.F. TRIESTE, 06TS3542, ITA | 1 | 0 | 1 | 0 | 0 | 0 | 0 | 6 |
| |  sss, , ITA | 1 | 0 | 1 | 0 | 0 | 0 | 0 | 6 |
| 23 |  A.S.DILETTANTISTICA GALAXY VOLLEY, 08PR3510, ITA | 2 | 0 | 0 | 1 | 0 | 1 | 0 | 4 |
| |  ASSOCIAZIONE SPORTIVA DILETTANTISTICA DOJO JUDO UDINE, 06UD1888, ITA | 3 | 0 | 0 | 1 | 0 | 1 | 0 | 4 |
| |  A.S.C.Dilettantistica BEAR BROTHERS CLUB, 06TS3975, ITA | 1 | 0 | 0 | 1 | 0 | 0 | 0 | 4 |
| |  S.S.DILETTANTISTICA CORPO LIBERO srl, 06GO3590, ITA | 2 | 0 | 0 | 1 | 0 | 0 | 0 | 4 |
| 27 |  UNIONE GINNASTICA GORIZIANA SOCIETA SPORTIVA DILETTANTISTICA, 06GO0004, ITA | 1 | 0 | 0 | 0 | 1 | 0 | 0 | 0 |